

Vimmerby

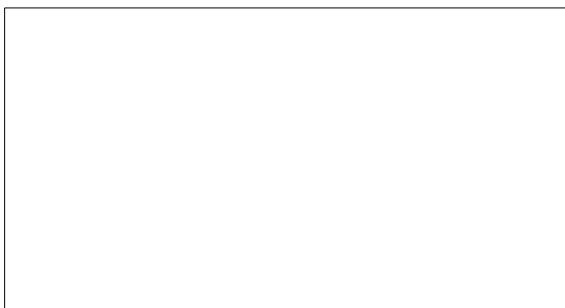

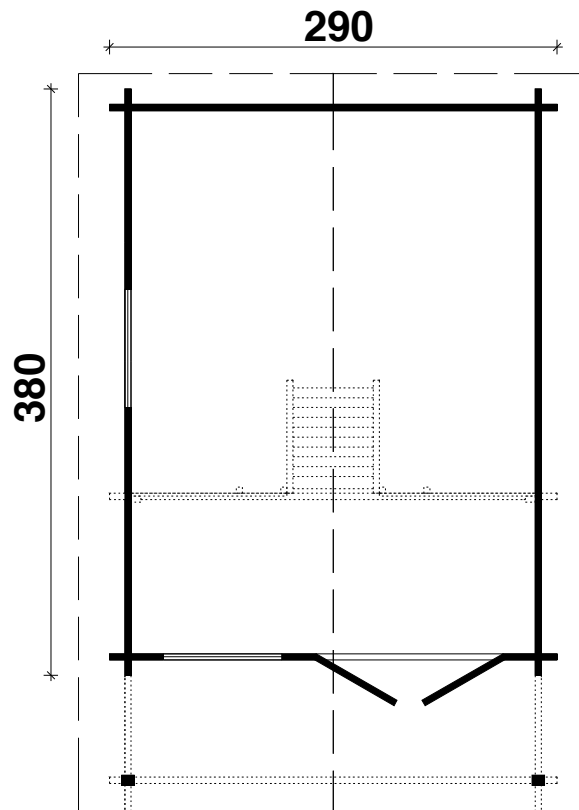







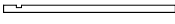



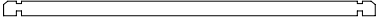

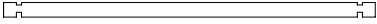
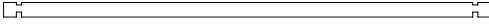

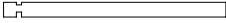
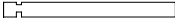





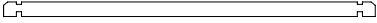
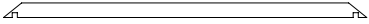
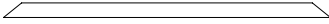
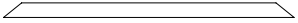





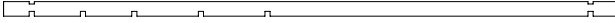

Byggyta: 290 x 380 cm

Yttermått: 270 x 360 cm · Väggtjocklek: 40 mm











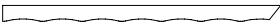









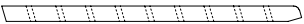

Note: All dimensions are approximate !

Vimmerby

Nr.	Beskrivning	Profil mm	Längd mm	Antal
001	Grundreglar		2690	2
002			3450	6
003			1340	1
004			350	1
005			2900	1
006			2900	2
007			2900	21
008			3800	25
009			1735	9
010			1340	8
011			1295	9
012			350	26
013			220	9
014			4700	2
015			4800	2
016/01			2900	2
016/02			2834	2
016/03			2551	2
016/04			2267	2
016/05			1984	2
016/06			161	4
016/07			1270	2
016/08		1417	2	
016/09		1134	2	
016/10		850	2	
016/11		567	2	
016/12		115	4	
017		 40 x 145	4800	2(1+1)
018		 40 x 143	2900	2
019			4800	1
020		 70 x 143	4800	2
021	Pardörr ca. 1200 x 1955mm - 40 mm			1
022	Fönster ca. 765 x 990 mm - 40 mm			2
023	Golvbrädor		2617	32+1
024			1850	24
025	Lister		ca. 26,0 m	
026	Bjälke	40 x 90	2620	1
027	Takbrädor		2120	88+2

Vimmerby

Nr.	Beskrivning	Profil mm	Längd mm	Antal
028	Takfotsbräor 		2170	4
029	Takkant		2170	4
030	Takkantsförstärkning		4800	2
031	Takkantsförstärkning		4800	2
032	Romb			2
033	Stormbräda 		2150	4
034	Stormbräda 		710	4
035	Stolpe 		1965	2
036	Justerbar stolpfot			2
037	Stege 		2318	2
038	Stege		520	9
039	Staket		680	6
040	Staket 		965	2
041	Staket		740	2
042	Kant 		4320	2
043	Kant		200	4
044	Bult M 8 x 70, Mutter, brickor			20
045	Spikar 2,2 x 50 ; 1,4 x 35			1 Bag
046	Stegfäste 			2(1+1)
047	Skruvar 4,0 x 40 ; 5,0 x 70 ; 5,0 x 100 ; 6,0 x 140			1 Bag
048	Slagblock		300-400	

Vimmerby

Grundreglar

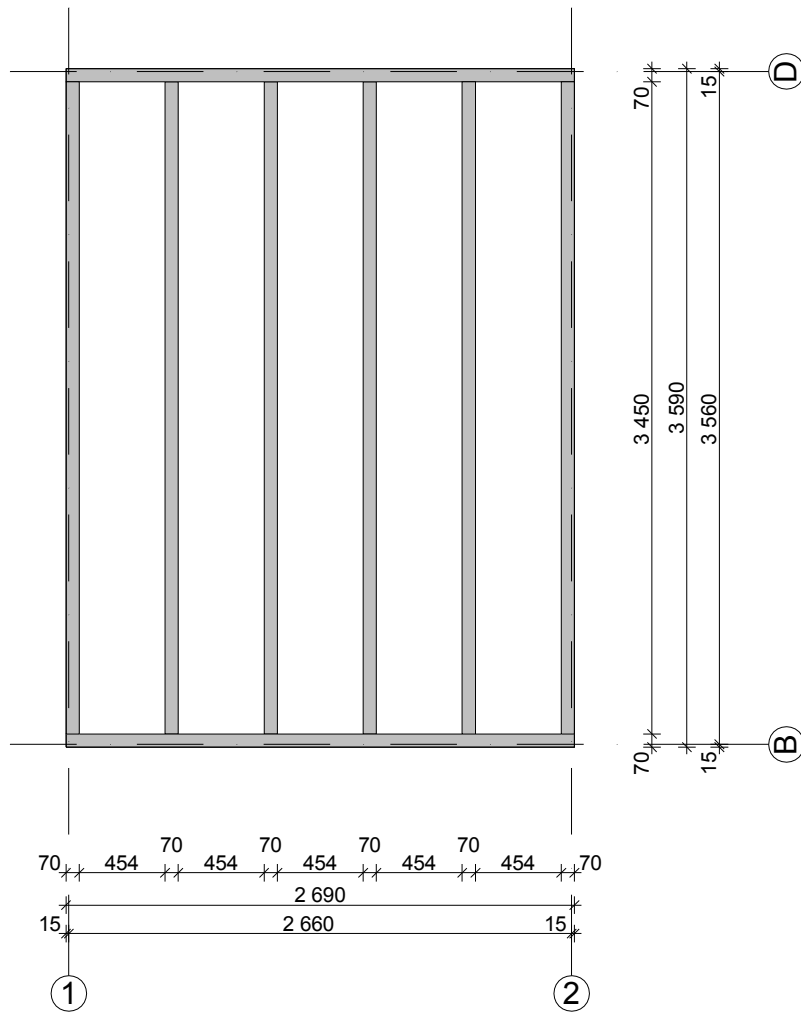

Vimmerby

Väggar

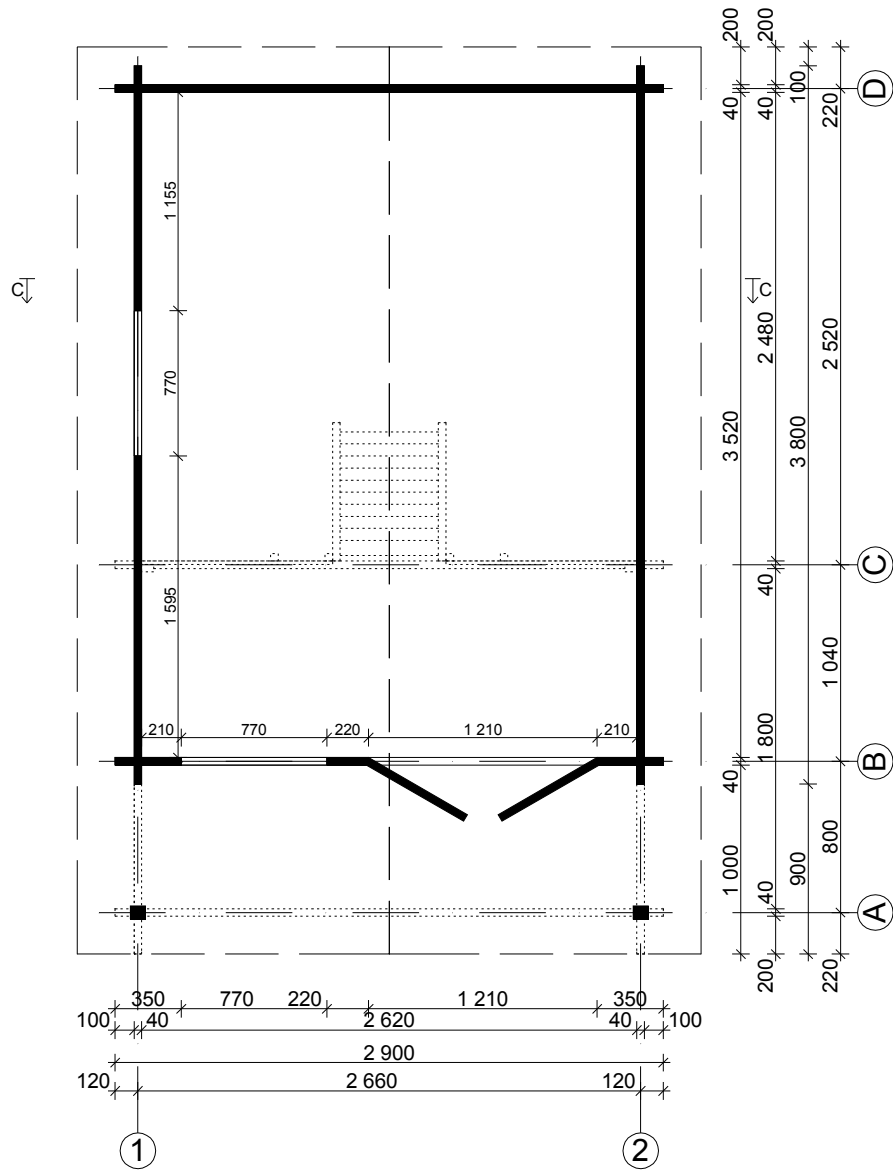

Vimmerby

A

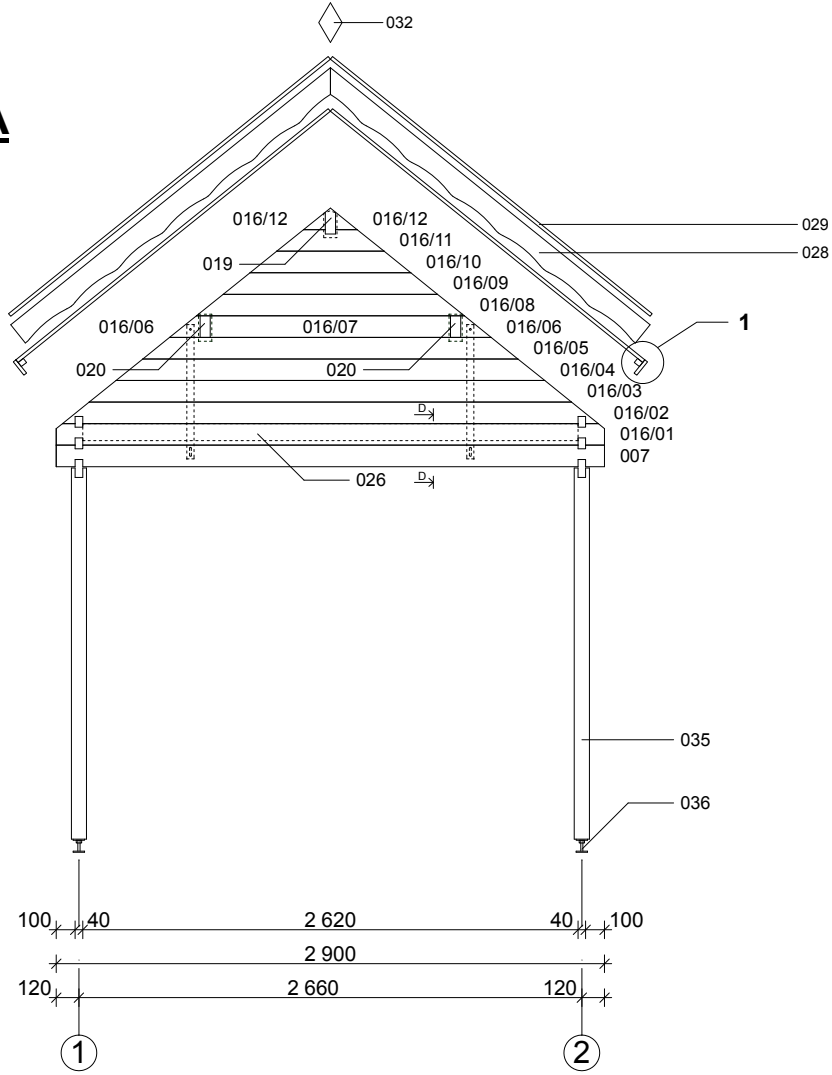

B

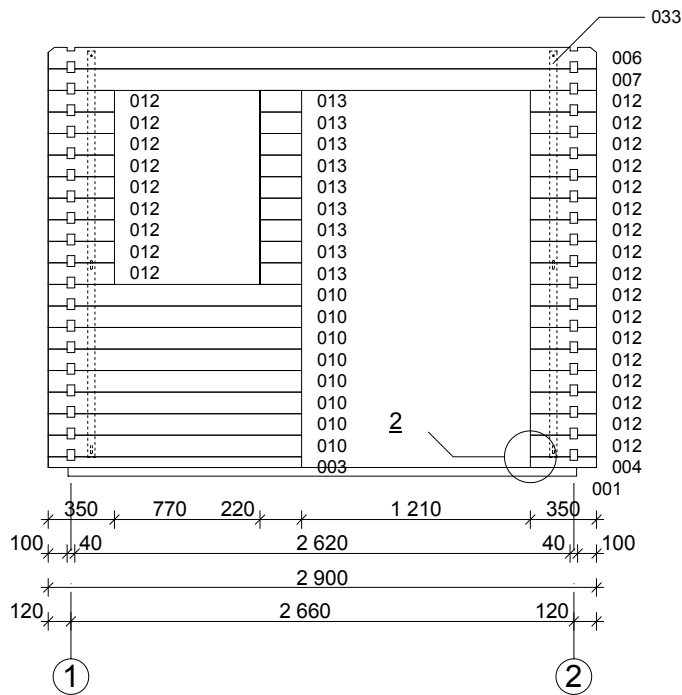

Vimmerby

C

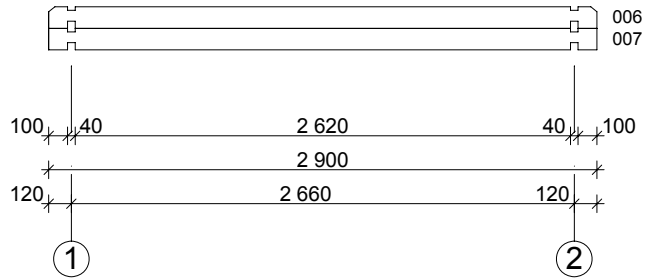

D

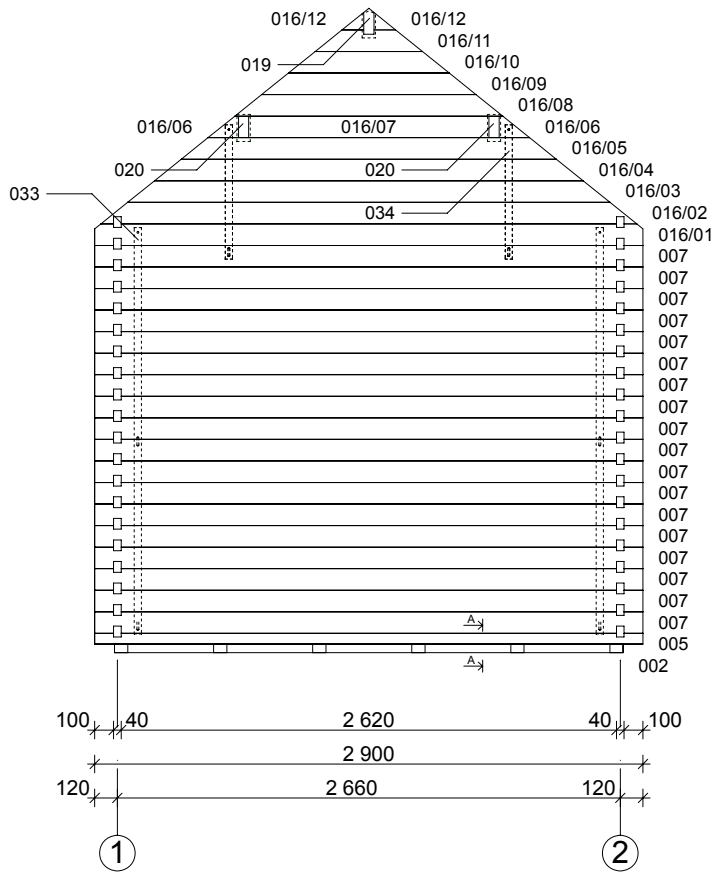

Vimmerby

1

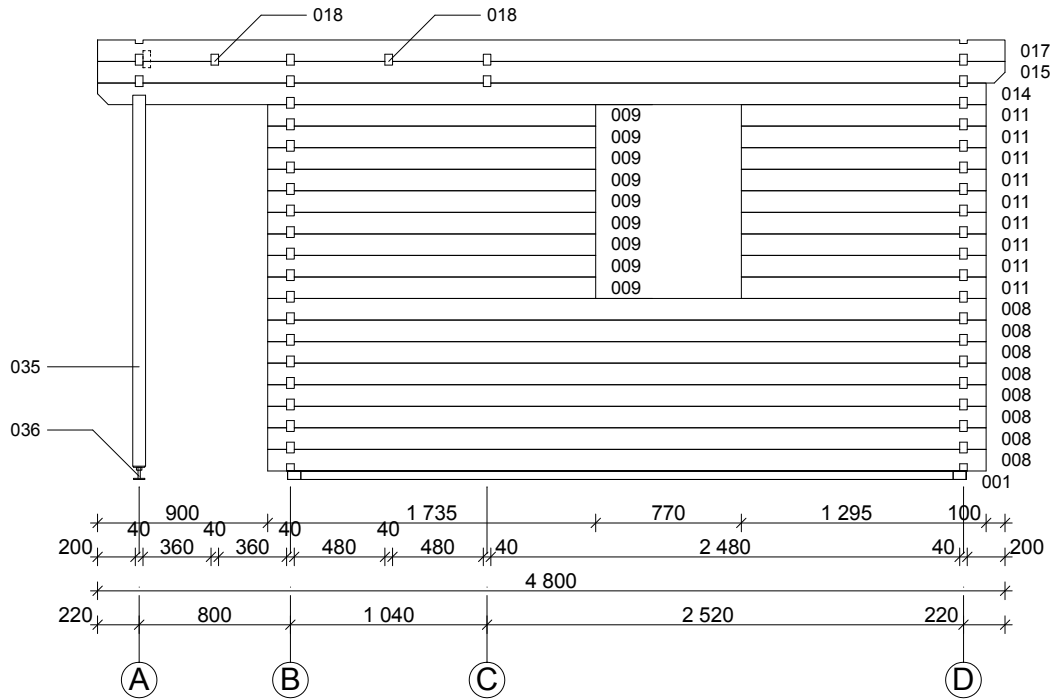

2

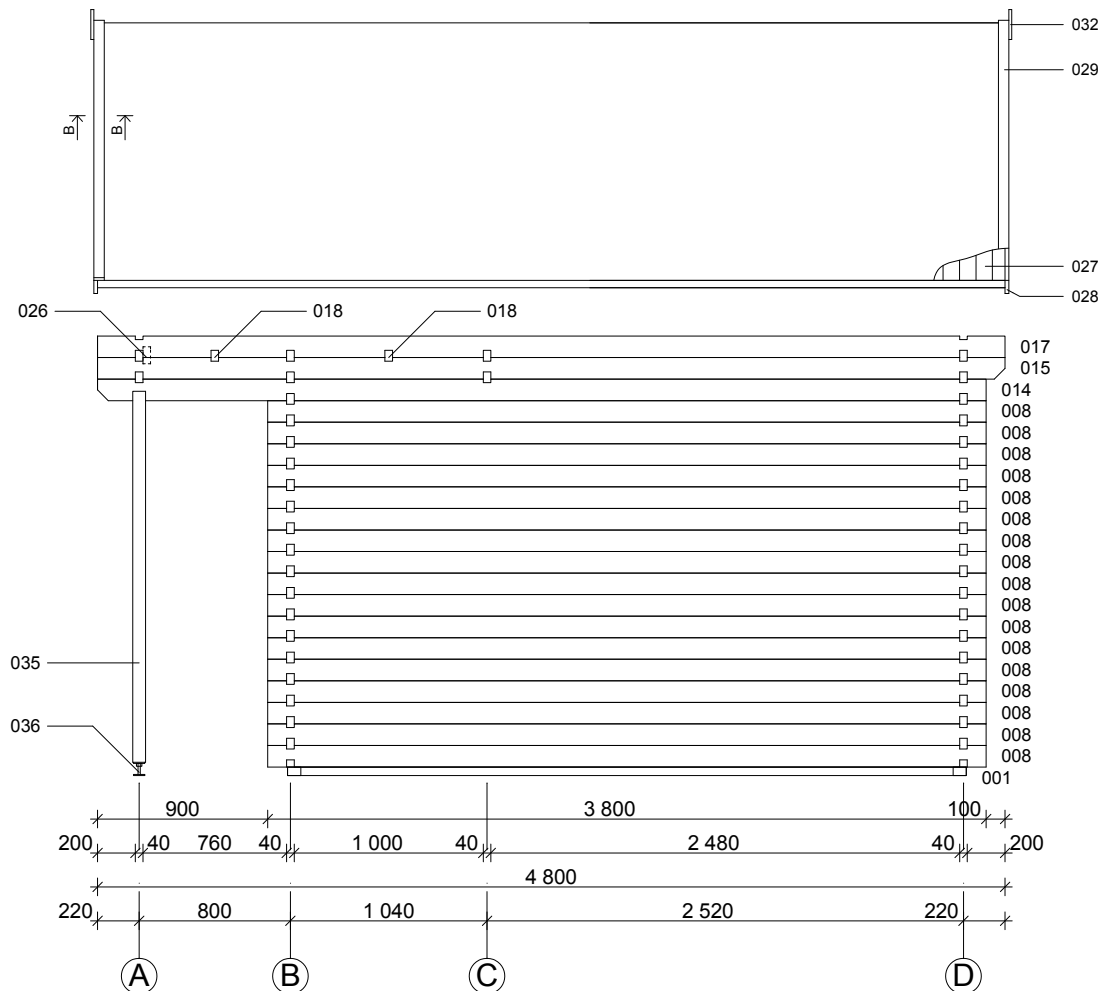

Vimmerby

C - C

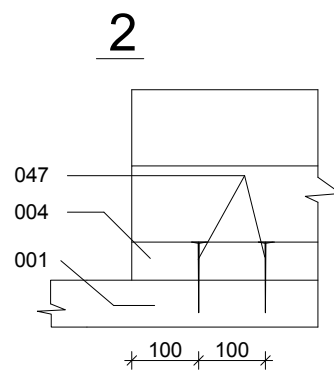
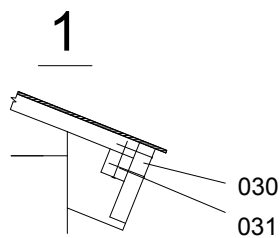
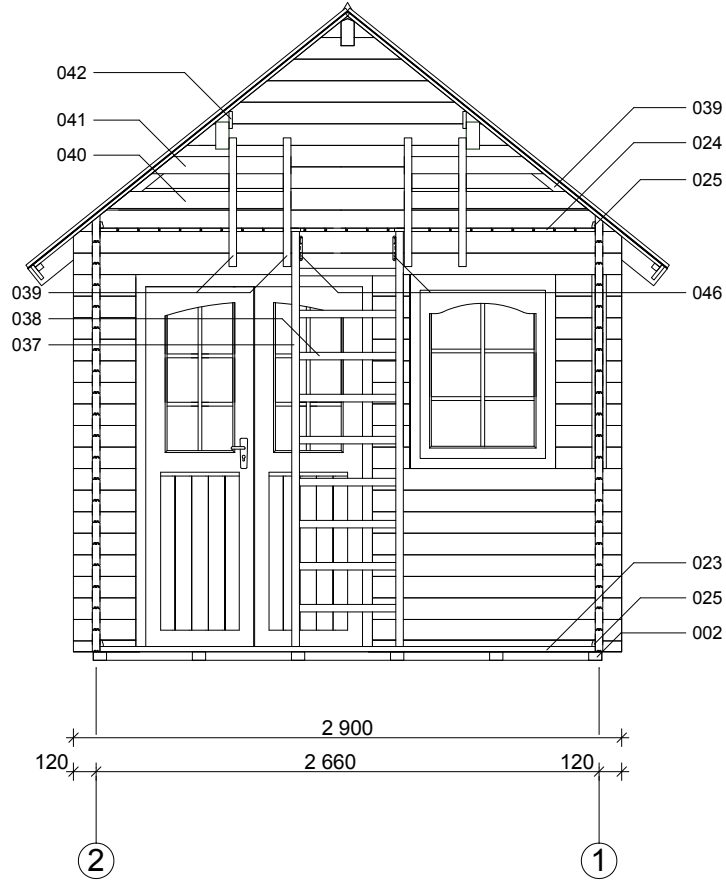

A-A

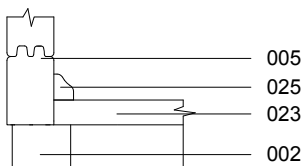

B-B

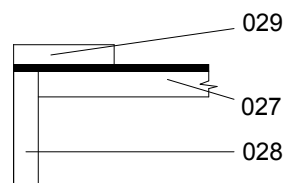

D-D

