

# Cornelis

1/6



29.09.2015

GROUNDPLAN - GRUNDPLAN - PLAN DE MASSE

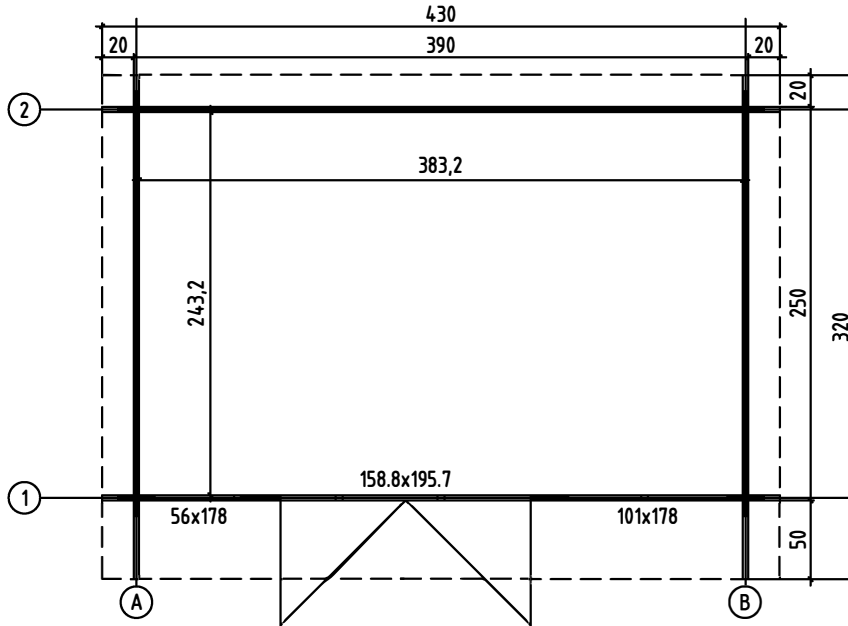

FOUNDATION - FUNDAMENT - FONDATION

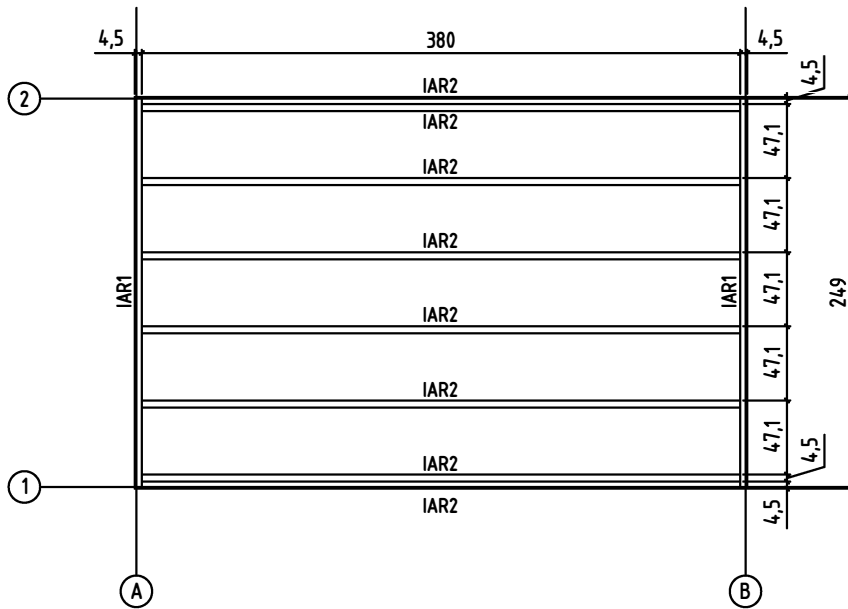



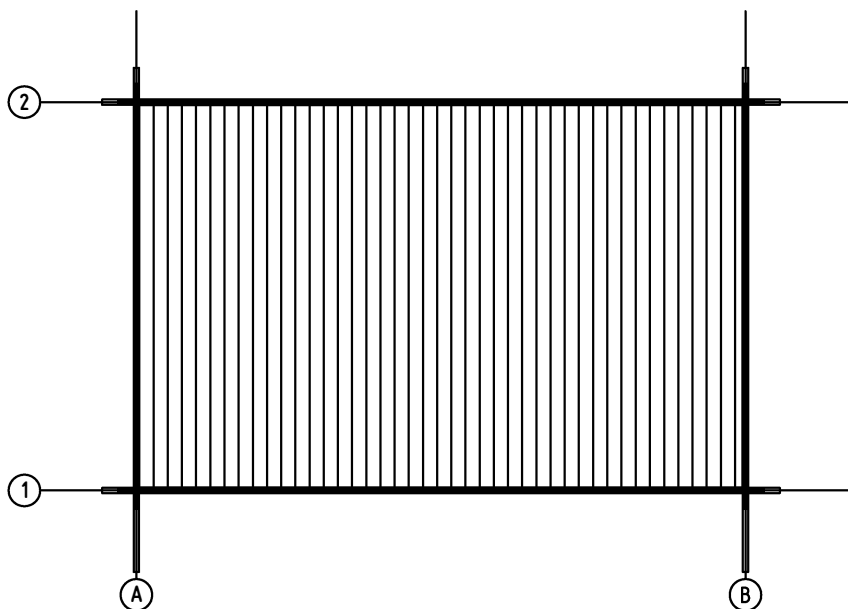

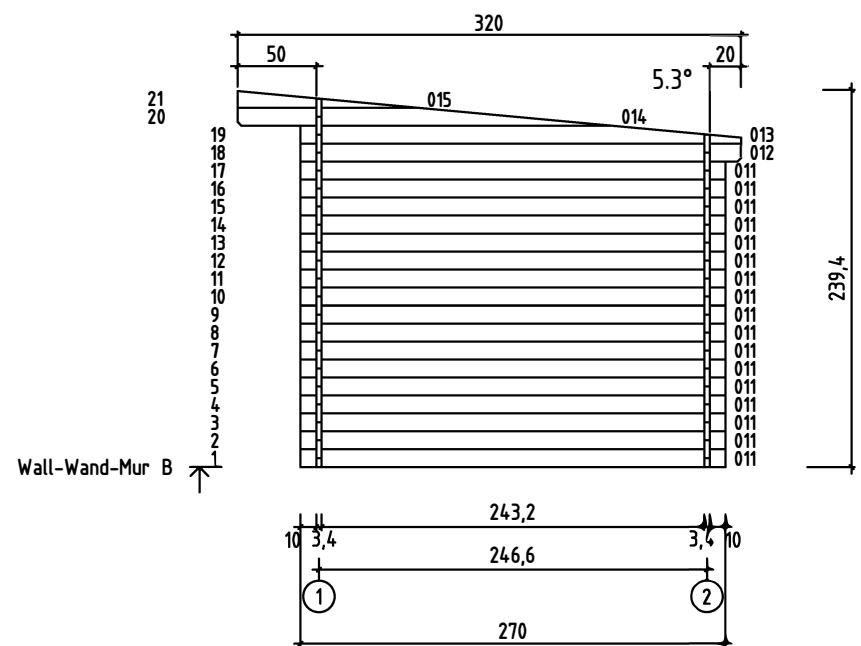
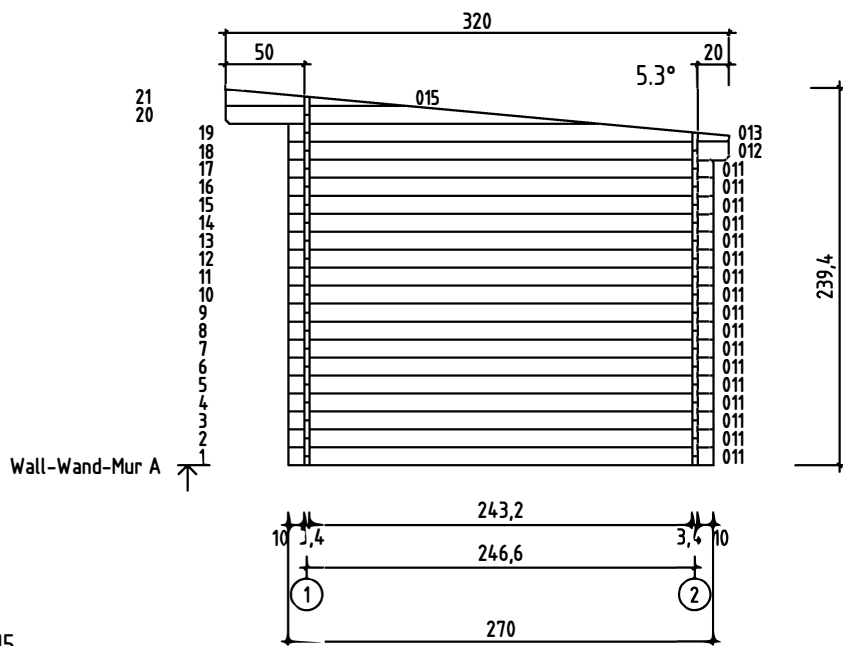
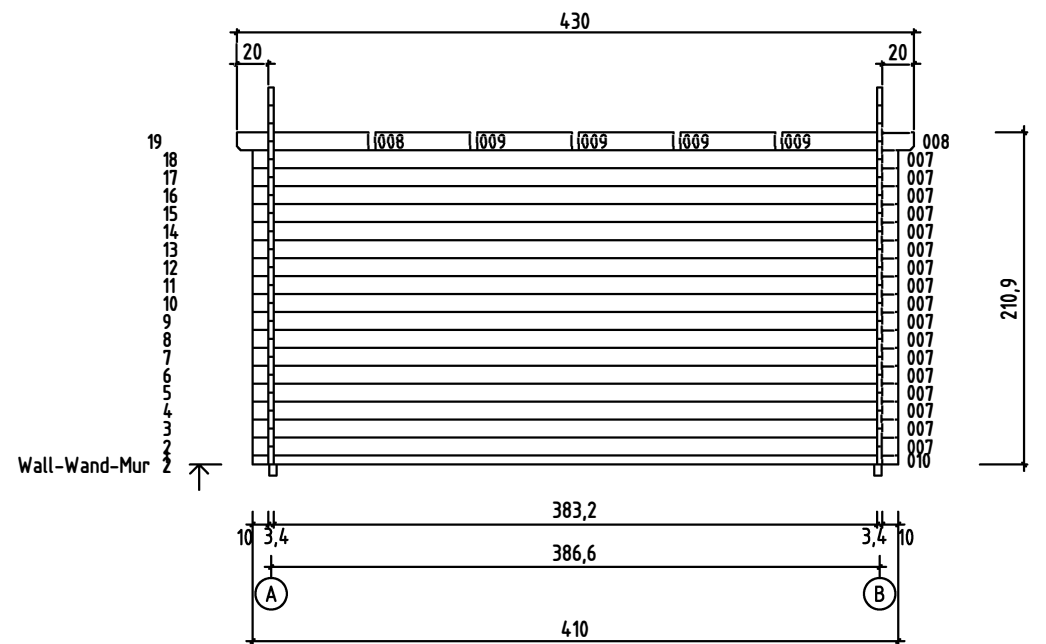
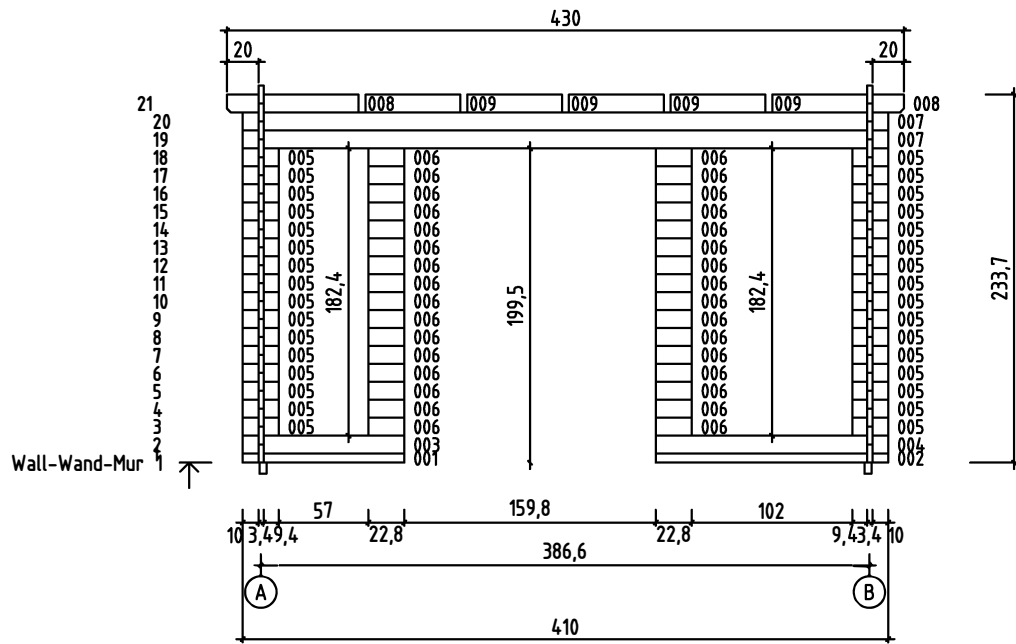



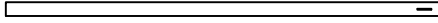
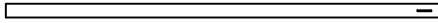
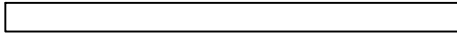
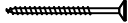
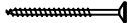
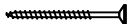
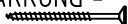
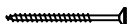





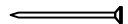

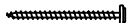
FLOOR BOARDS - FUSSBODENBRETTER - PLAN POSE PLANCHER

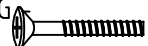

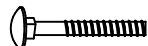

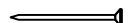
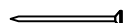
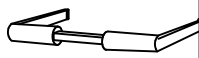
Pos	29.09.2015	Piece list - Stückliste - Liste des pièces	4/6	Q.	P (mm)	L (mm)
001				1	34x57	1026
002				1	34x57	1476
003				1	34x114	1026
004				1	34x114	1476
005				32	34x114	228
006				32	34x114	228
007				19	34x114	4100
008				4	34x114	836
009				8	34x114	602
010				1	34x57	4100
011				34	34x114	2700
012				2	34x114	2800
WA-1				1		
WB-1				1		
IAR2		FOUNDATION - FUNDAMENT - FONDATION		8	45x70	3800
IAR1		FOUNDATION - FUNDAMENT - FONDATION		2	45x70	2490
SR1		RAFTER - DACHSPARREN - CHEVRON		5	44x140	3227
DB	FLOOR BOARDS - FUSSBODENBRETTER - LAME DE PLANCHER			43	90x18	2428
DB	ROOF BOARDS - DACHBRETTER - VOLIGES			36	90x18	4300
FL	FLOOR FILLET-FUSSBODENLEISTE - CORNIERE DE FINITION DU PLANCHER				18x18	12.51
DPL	ROOFING FELT FILLET - DACHPAPPENLEISTE - BAGUETTE DE FIXATION DU FEUTRE BITUMEUX			2	18x58	3250
DPL	ROOFING FELT FILLET - DACHPAPPENLEISTE - BAGUETTE DE FIXATION DU FEUTRE BITUMEUX			1	18x58	4220
TB	EAVES BOARD - TRAUFBRETT - BANDEAU DE TOIT			2	18x120	3227
DRV	ROOF EDGE REINFORCEMENT - DACHRANDVERSTÄRKUNG - CORNIERE DE RENFORT DE BORD DE TOIT			2	28x34	200
DRV	ROOF EDGE REINFORCEMENT - DACHRANDVERSTÄRKUNG - CORNIERE DE RENFORT DE BORD DE TOIT			2	28x34	500

Pos	29.09.2015	Piece list - Stückliste - Liste des pièces	5/6	Q.	P (mm)	L (mm)
DRV	ROOF EDGE REINFORCEMENT - DACHRANDVERSTÄRKUNG - CORNIERE DE RENFORT DE BORD DE TOIT			2	28x34	2440
KFS	STORM PROTECTION - STURMLEISTE - LATTE ANTI-TEMPETE			2	22x45	2250
KFS	STORM PROTECTION - STURMLEISTE - LATTE ANTI-TEMPETE			2	22x45	2050
GL	GABLE MOULDING - GIBELLEISTE - PLANCHE DE RIVE			3	18x120	4336
HS16	SCREW FOR GABLE MOULDING - SCHRAUBEN FÜR GIBELLEISTE - VIS DE FIXATION POUR PLANCHE DE RIVE			42	3.5X50	
HS3	SCREW FOR DOOR FILLET - SCHRAUBE ZUR BEFESTIGUNG TÜRLEISTE - VIS D'ASSEMBLAGE DU CADRE DE PORTE			5	3X30	
HS32	SCREW FOR EAVES BOARDS - SCHRAUBEN FÜR TRAUFBRETTEN - VIS DE FIXATION POUR BANDEAU DE TOIT			16	4X40	
HS26	SCREW FOR ROOF EDGE REINFORCEMENT - SCHRAUBEN FÜR DACHRANDVERSTÄRKUNG - VIS POUR RENFORT DE BORD DE TOIT			20	4X40	
HS91	SCREW FOR RAFTER - SCHRAUBEN FÜR DACHSPARREN - VIS POUR CHEVRON			14	5X120	
HS42	SCREW FOR GABLE - SCHRAUBEN FÜR GIEBEL - VIS POUR FIXATION DES PIGNONS			8	5X120	
HS39	SCREW FOR FUNDAMENT - SCHRAUBEN ZUR BEFESTIGUNG FUNDAMENT - VIS POUR FONDATION			30	5x90	
HS41	SCREW FOR DOOR JAMB - SCHRAUBE FÜR TÜRRAHMEN - VIS DE FIXATION POUR MONTANT DE PORTE			4	5x90	
HS48	SCREW FOR DET 008,009- SCHRAUBE FÜR DET 008,009 - VIS POUR DET 008,009			24	6x180	
FS2	WINDOW HANDLE FITTINGS-FENSTERGRIFF - POIGNÉE D'OUVERTURE DE FENETRE			2		
NFF	ZN NAIL FOR FLOOR FILLET - ZN NÄGEL FÜR FUSSBODENLEISTE - POINTE POUR CORNIERE DE FINITION DU PLANCHER			26	1.4x40	
SH34	HAMMER BLOCK - SCHLAGHOLZ - CALLE DE FRAPPE			1		
MS	SCREW FOR DOORSTEP - SCHRAUBEN FÜR TÜRSCHWELLE - VIS DE FIXATION DU SEUIL DE PORTE			3	4.5X65	
NFD	ZN NAIL FOR ROOFING FELT FILLET - ZN NÄGEL FÜR DACHPAPPENLEISTE - POINTE POUR BAGUETTE FIXATION FEUTRE BITUMEUX			26	2X40	
TS	BOLT FOR WINDOW HANDLE FITTINGS - BOLZEN FÜR FENSTERGRIFF BESCHLAG BOULON POUR POIGNÉE D'OUVERTURE DE FENETRE			4		
SFS	NUT FOR STORM PROTECTION - SCHRAUBENMUTTER FÜR STURMLEISTE - ÉCROU POUR LAME ANTI-TEMPETE			8		
BFS	BOLT FOR STORM PROTECTION - BOLZEN FÜR STURMLEISTE - VIS POUR LAME ANTI-TEMPETE			8		
DFS	WASHER FOR STORM PROTECTION - DICHTSCHEIBE FÜR STURMLEISTE - RONDELLE POUR LAME ANTI-TEMPETE			8		
NF2	ZN NAIL FOR ROOF - ZN NÄGEL FÜR DACHBRETTEN - POINTE POUR TOIT			271	2X50	
NH1	ZN NAIL FOR FLOOR - ZN NÄGEL FÜR FUSSBODENBRETTEN - CLOUS POUR PLANCHER			264	2X50	
TS3	DOOR HANDLE FITTINGS-TÜRGRIF - SET DE GARNITURES DE SERRURE DE PORTE			1		

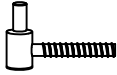
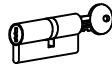
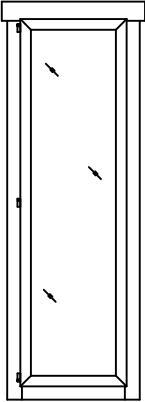
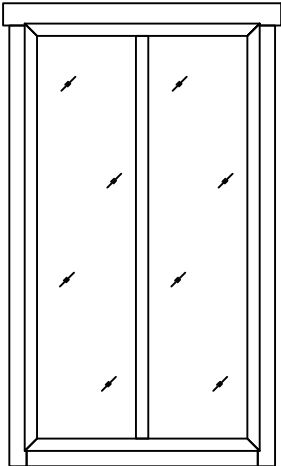
Pos	29.09.2015	Piece list - Stückliste - Liste des pièces	6/6	Q.	P (mm)	L (mm)
TS4	SET OF DOOR LOCK COVERS - SCHLOSSBLENDEN - SET DE GARNITURES DE SERRURE DE PORTE			1		
TS2	MALE BOLT HINGE FOR DOOR - TÜRRIEGEL - PARTIE MALE DE CHARNIERE DE PORTE			6		
TS6	CYLINDER LOCK - ZYLINDERSCHLOSS - CYLINDRE DE SERRURE			1		
	WINDOW - FENSTER - FENETRE 560x1780      AK.1.100.PVV		DGP	1		
						
	WINDOW - FENSTER - FENETRE 1010x1780      TAK.1.100.PMO.e		DGP	1		
						
	DOOR - TÜR - PORTE 1588x1957      TUK.1.100.PVP.MM		DGP	1		
	