

Gudrun B

1/6

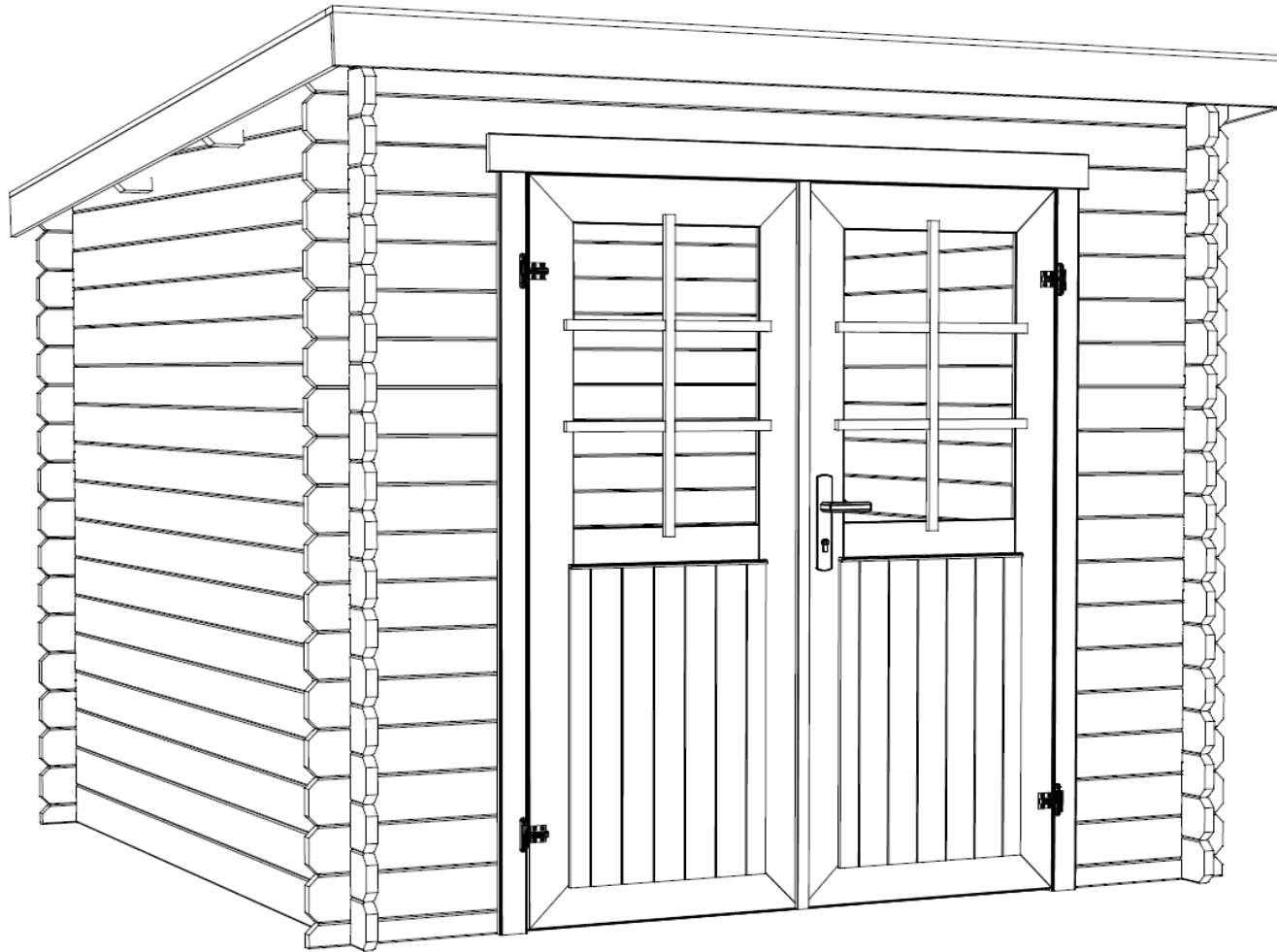





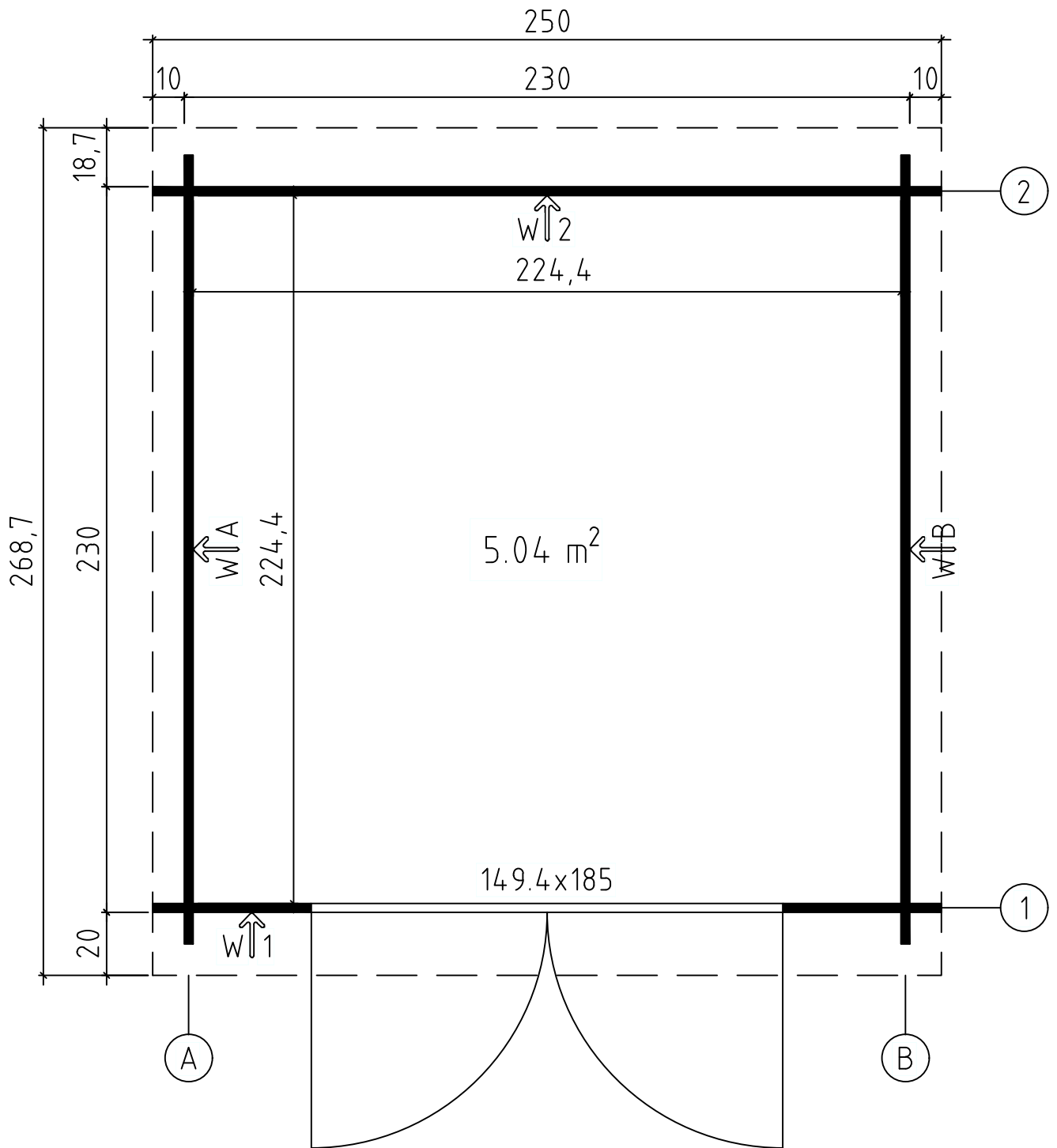

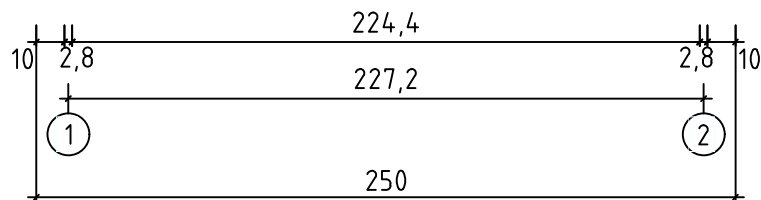
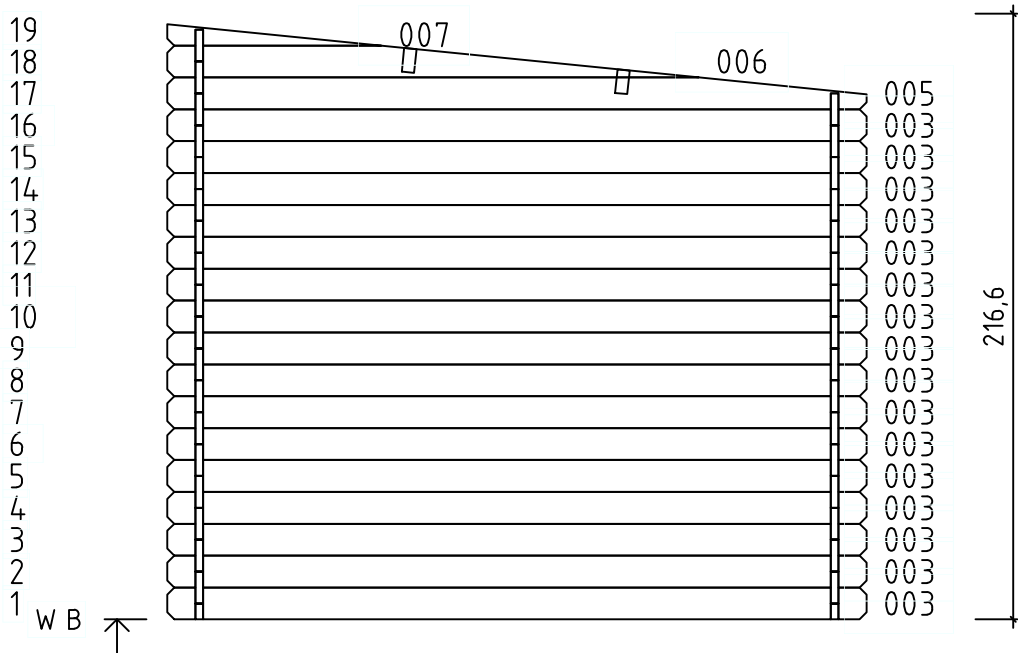
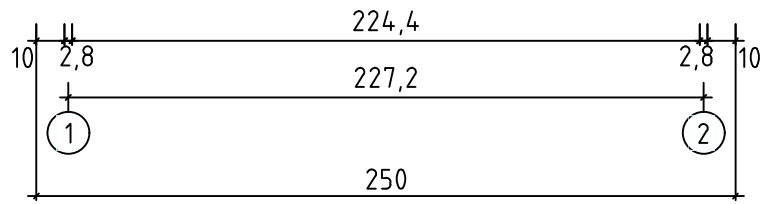
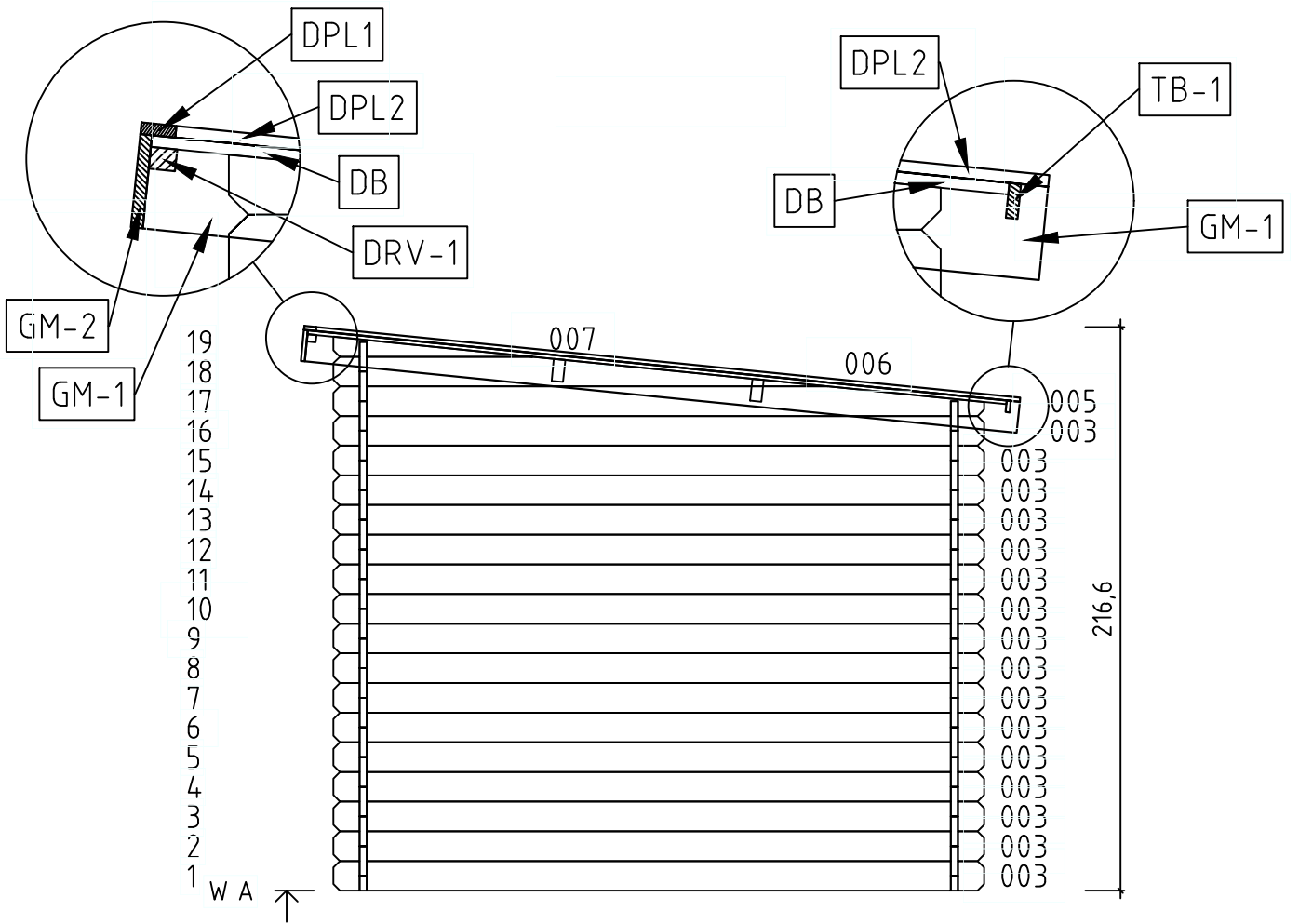



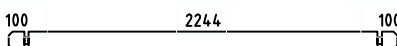
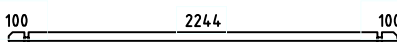
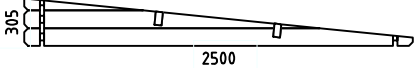
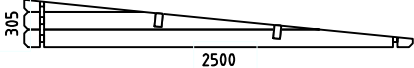
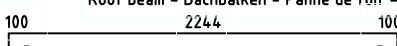

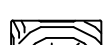

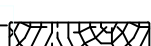

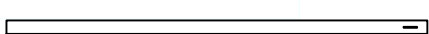
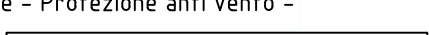
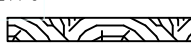
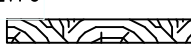



24.08.2017

Groundplan - Grundplan - Plan de masse -
Planimetria - Plattegrond - Põhiplaan

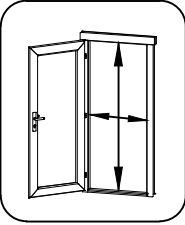
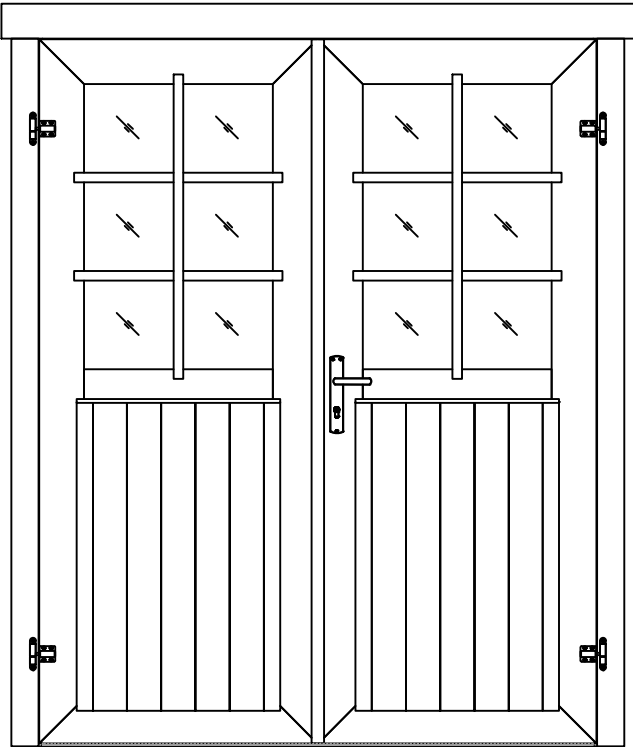

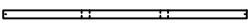
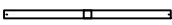

| Pos | 24.08.2017 Piece list - Stückliste - Liste des pièces - Elementi - Stuklijst - Joonis Art.Nr. 2834150 | 5/6 | Q | P (mm) | L (mm) |
|-------|---|-----|----|-----------|-----------|
| 001 |  | | 2 | 28x57 | 500 |
| 002 |  | | 32 | 28x114 | 500 |
| 003 |  | | 50 | 28x114 | 2500 |
| 004 |  | | 1 | 28x57 | 2500 |
| WA-1 |  | | 1 | | |
| WB-1 |  | | 1 | | |
| A-PR1 | Roof beam - Dachbalken - Panne de toit - Perlina del tetto - Gordingen / dakbalk - Abipärliid  | | 2 | 44x120 | 2500 |
| DB | Roof boards - Dachbretter - Voliges - Perlina per tetto - Dakhout - Katuselaud  | | 28 | 90x15 | 2700 |
| DPL1 | Roofing felt fillet - Dachpappenleiste - Baguette de fixation du feutre bitumeux - Asse per fissaggio guaina bituminosa - Afdekljst asfaltpapier - Katusepapiilist  | | 1 | 15x45 | 2530 |
| DPL2 | Roofing felt fillet - Dachpappenleiste - Baguette de fixation du feutre bitumeux - Asse per fissaggio guaina bituminosa - Afdekljst asfaltpapier - Katusepapiilist  | | 2 | 15x45 | 2720 |
| DPP-1 | Roofing felt (strip) - Dachpappe (bahnen) - Feutre bitumeux (bande) - Cartone catramato - Asfaltpapier (baan) - Katusepapp  | | 3 | | 2600 |
| TB-1 | Fascia board - Traufbrett - Bandeau de toit - Finitura lati tetto - Gevellijst Räästalaud  | | 1 | 15x45 | 2500 |
| DRV-1 | Roof edge reinforcement - Dachrandverstärkung - Corniere de renfort de bord de toit - Rinforzo x tetto - Dakrand versterking - Räästatugevdus  | | 1 | 28x34 | 2500 |
| KFS-1 | Storm protection - Sturmleiste - Latte anti-tempete - Protezione anti vento - Stormverankering / beveliging - Tormikinnitus  | | 2 | 22x45 | 2050 |
| KFS-2 | Storm protection - Sturmleiste - Latte anti-tempete - Protezione anti vento - Stormverankering / beveliging - Tormikinnitus  | | 2 | 22x45 | 2500 |
| GM-2 | Gable moulding - Giebelleiste - Planche de rive - Finitura per frontale e retro del tetto - Gevellijst - Viilulaud  | | 1 | 15x120 | 2530 |
| GM-1 | Gable moulding - Giebelleiste - Planche de rive - Finitura per frontale e retro del tetto - Gevellijst - Viilulaud  | | 2 | 15x120 | 2750 |
| HS9 | Screw for gable moulding - Schrauben für giebelleiste - Vis pour fixation planche de rive - Vite per fissare finiture davanti e dietro del tetto - Schroef voor gevellijst - Krugi viilulauale  | | 16 | 3.5x50 | |
| HS4 | Screw for fascia boards - Schrauben für traufbretter - Vis pour fixation bandeau de toit - Viti x striscia del tetto - Schroef voor gevellijst - Krugi räästalauale  | | 6 | 3x30 | |
| HS12 | Screw for roof edge reinforcement - Schrauben für dachrandverstärkung - Vis pour fixation corniere renfort de bord de toit - Viti x rinforzo bordo tetto - Schroef voor dakrand versterking - Krugi räästatugevdusele  | | 6 | 4x40 | |
| HS12 | Screw for gable moulding - Schrauben für giebelleiste - Vis pour fixation planche de rive - Vite per fissare finiture davanti e dietro del tetto - Schroef voor gevellijst - Krugi viilulauale  | | 6 | 4x40 | |
| HS18 | Screw for roof beams - Schrauben für dachbalken - Vis pour fixation pannes de toit - Viti per perline del tetto - Schroef voor gordingen / dakbalken - Krugi pärlinitete  | | 4 | 5x120 | |
| HS18 | Screw for gable - Schrauben für giebel - Vis pour fixation des pignons - Viti per timpano - Schroef voor gevelpunt - Krugi viilude kinnitamiseks  | | 4 | 5x120 | |

| Pos | 19.12.2017 | Piece list - Stückliste - Liste des pièces - Elementi - Stuklijst - Tükítabel 14 94x1850 TUK.2.056.SVP.MMX28 SGA+28 | 1/2 | Q | P (mm) | L (mm) |
|--|---|--|---|---|---|-----------|
| Glass size - Glasgröße - Taille de la vitre - Misura del vetro - Glas afmeting - Klaasi mõõt: 502x750 mm | | | | |  1418x1794 mm | |
|  | | | | | | |
| 1 | Upper door jamb - Türrahmen oben - Cadre de porte supérieur - Telaio superiore della porta - Bovendorpel - Ukse ülemine leng | |  | 1 | 66x100 | 1438 |
| 2 | Left door jamb - Türrahmen links - Cadre de porte gauche - Telaio montante sinistro della porta - Linkerstijl deurframe - Ukse vasak leng | |  | 1 | 66x80 | 1850 |
| 3 | Right door jamb - Türrahmen rechts - Cadre de porte droit - Telaio montante destro della porta - Rechterstijl deurframe - Ukse parem leng | |  | 1 | 66x80 | 1850 |
| 4 | Doorstep - Swelle - Barre de seuil - Soglia della porta - Deurdorpel - Lävepakk | |  | 1 | 20x21 | 1418 |
| 5 | Connection strip - Deckleiste - Baguette de battement - Profilo verticale della porta - Stulplijst - Kokkuvältsiliist | |  | 1 | 13x32 | 1812 |
| 6 | Georgian bars - Sprossen - Croisillons - La griglia georgiana - Raamverdeling - Petteliistud | |  | 2 | 15x25 | 784 |
| 7 | Georgian bars - Sprossen - Croisillons - La griglia georgiana - Raamverdeling - Petteliistud | |  | 4 | 15x25 | 536 |



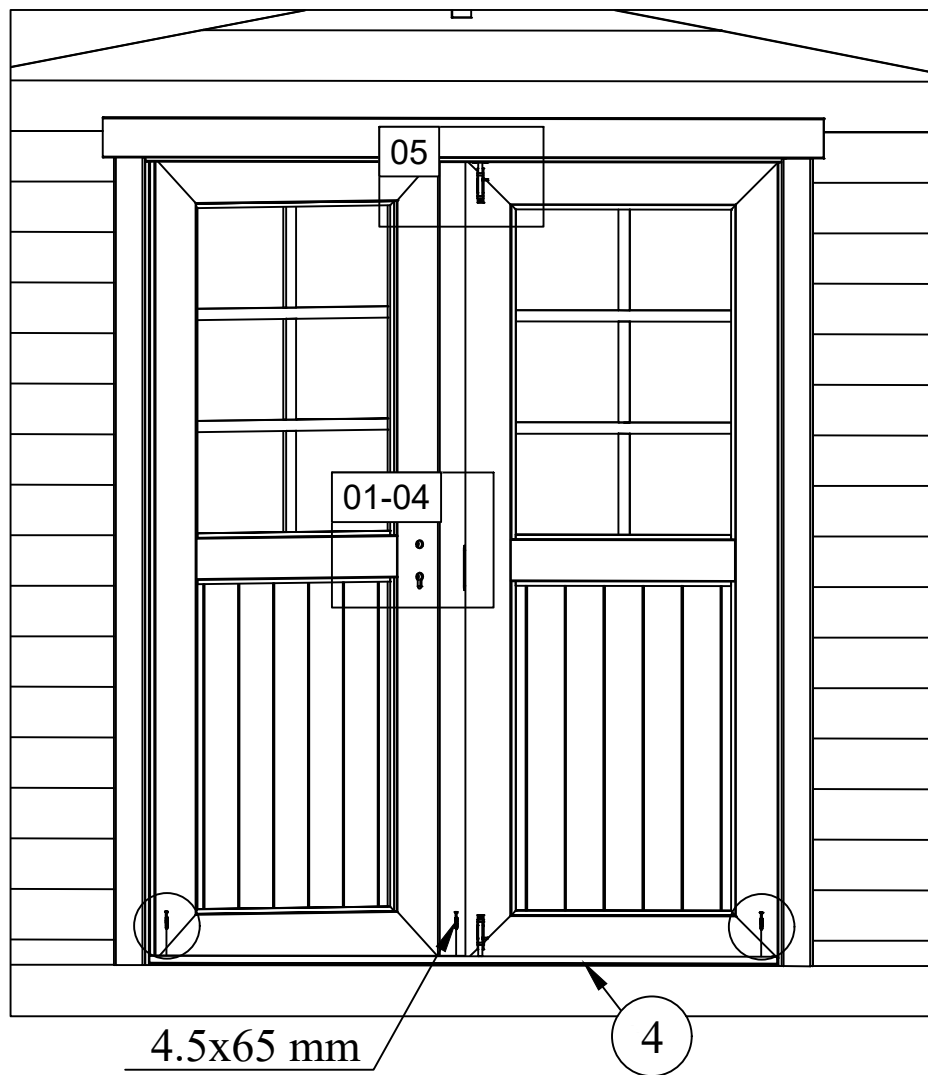

01



04

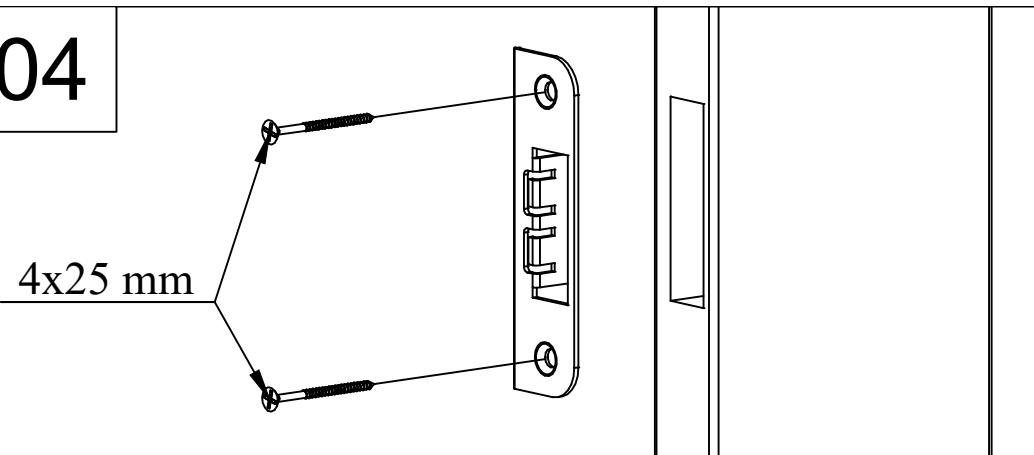

02



05

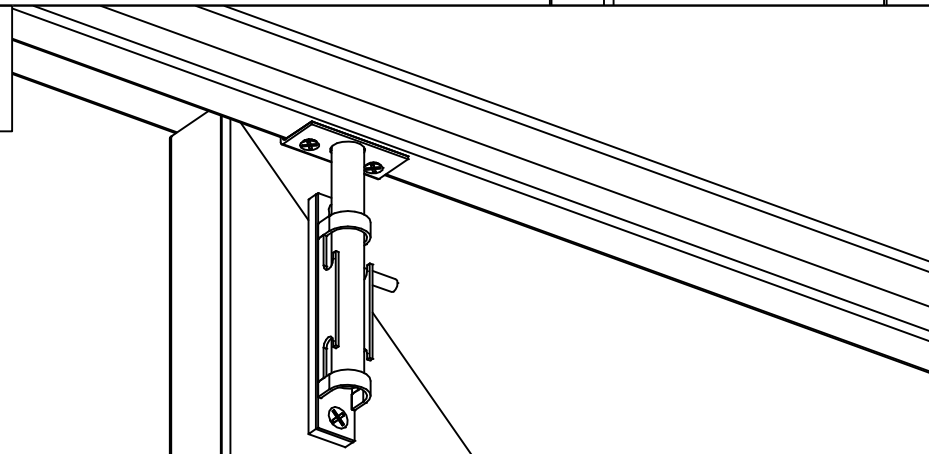

03

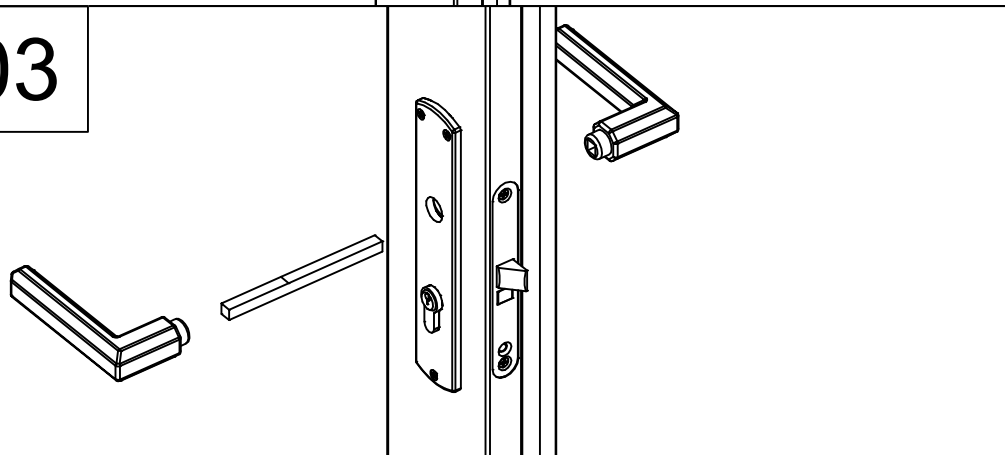

06

