

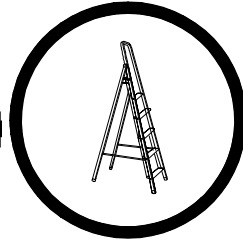

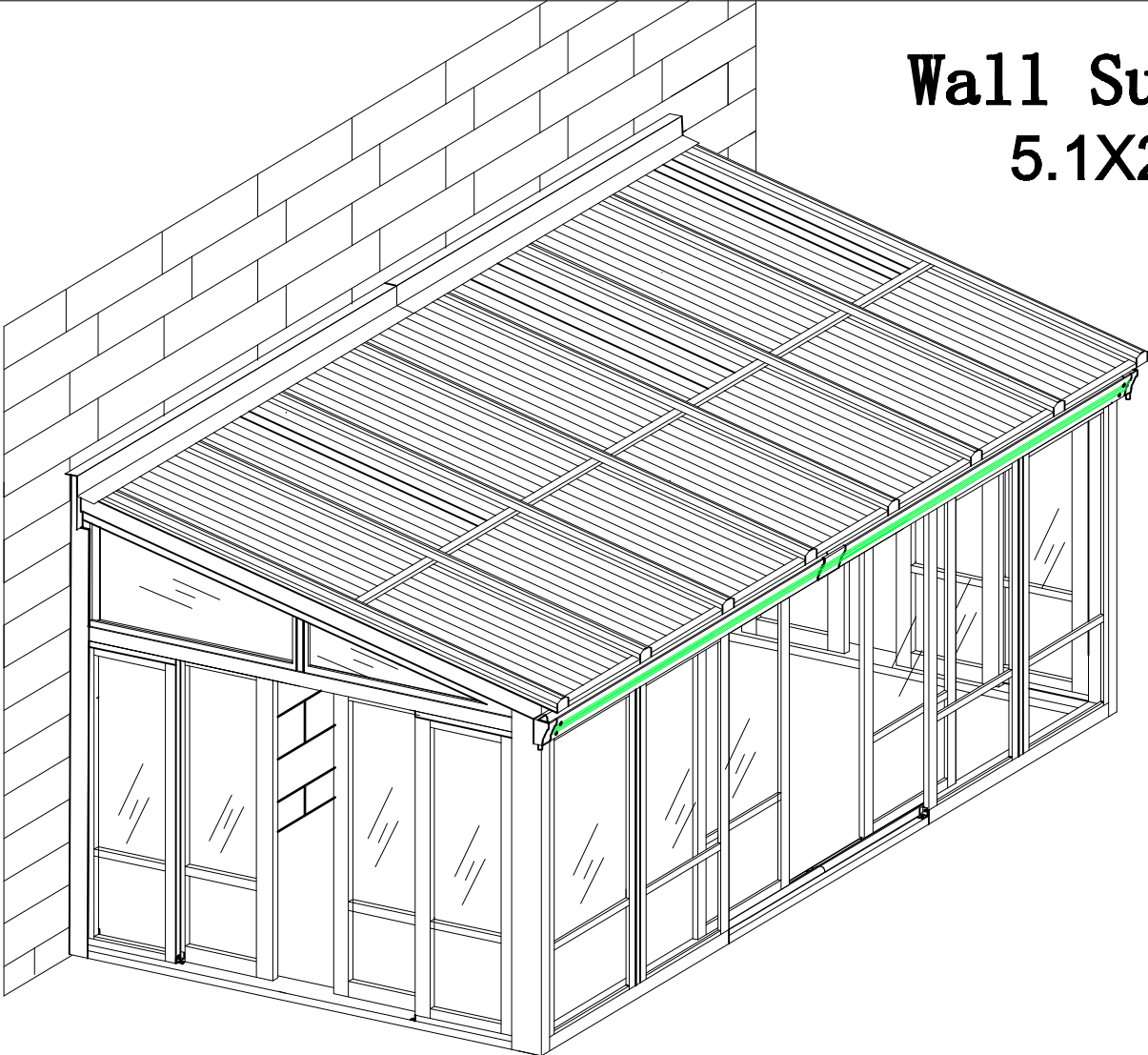

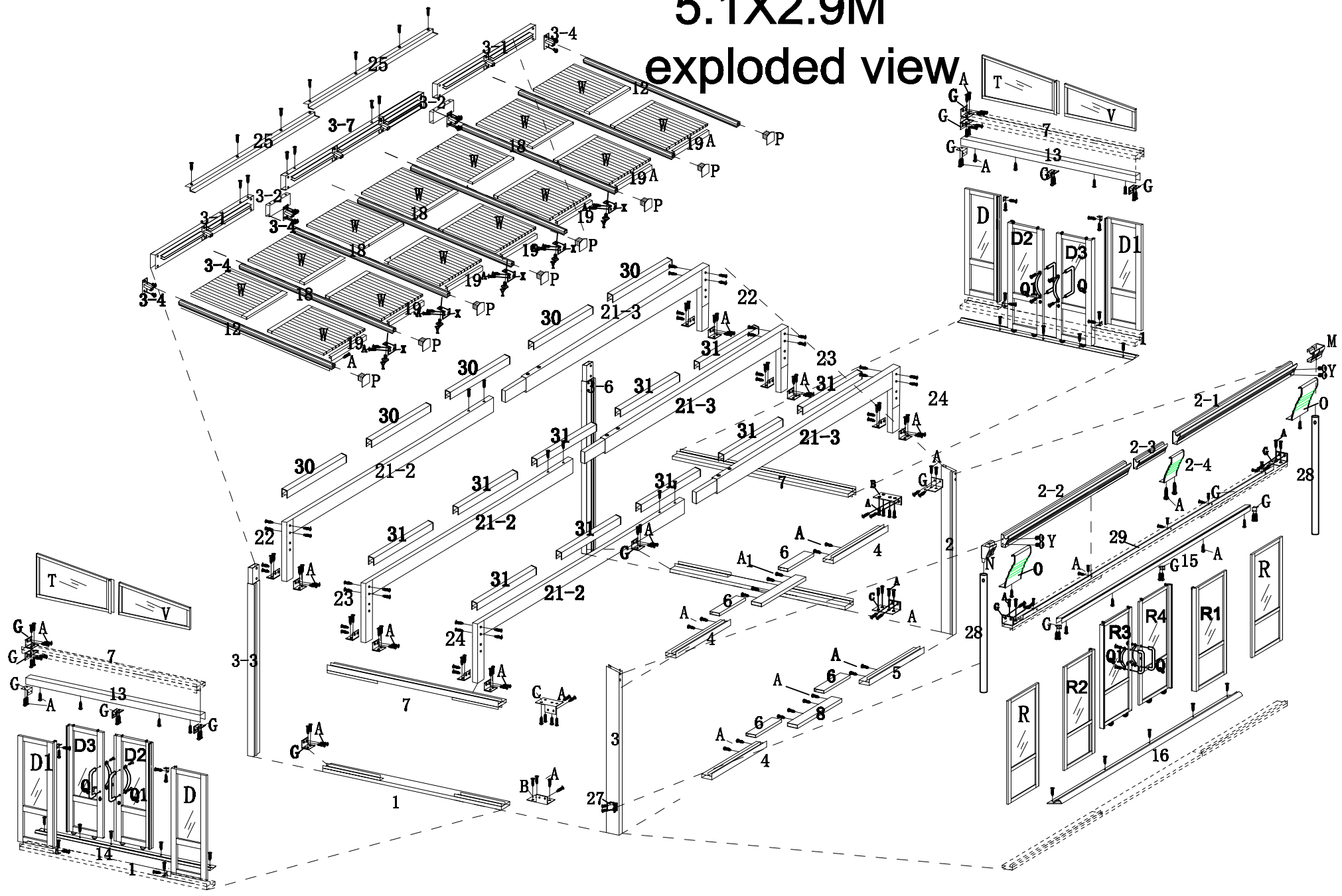





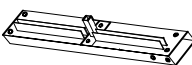

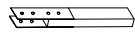

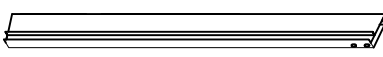

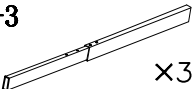
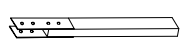

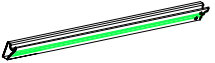

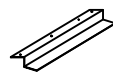

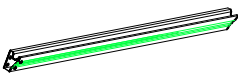
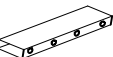



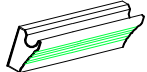

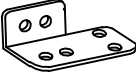
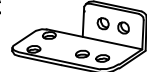



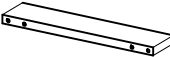

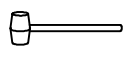

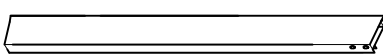





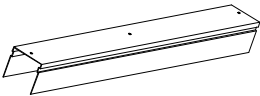

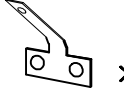

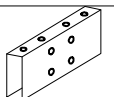

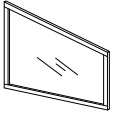
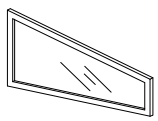
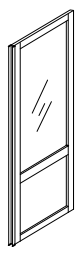

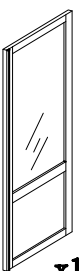
Wall Sun Room 5.1X2.9M

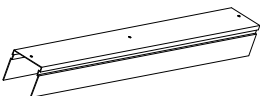
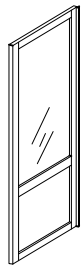
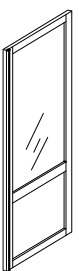
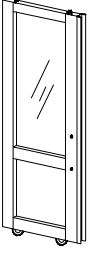
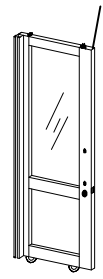
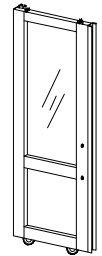
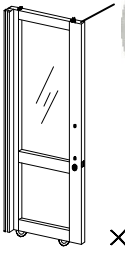

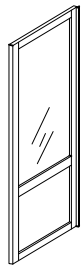
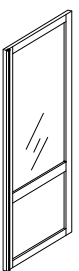
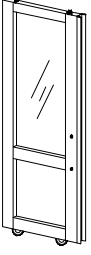
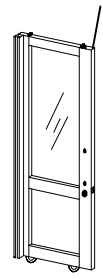
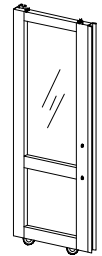
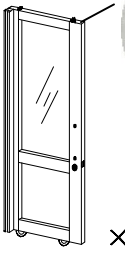

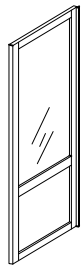
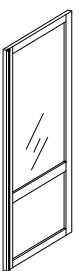
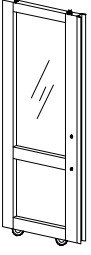
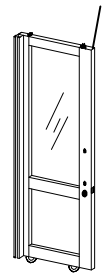
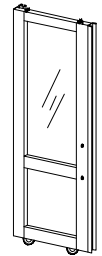
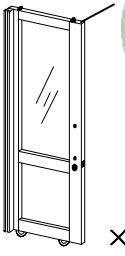

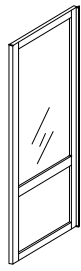
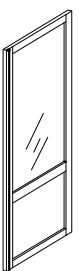
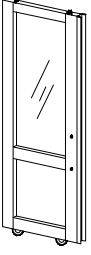
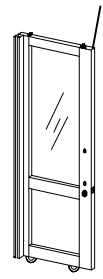
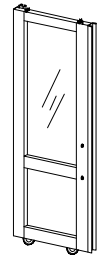
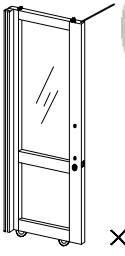
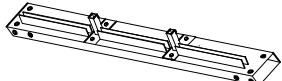
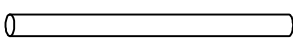
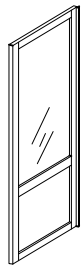
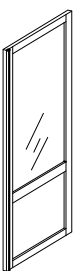
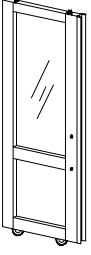
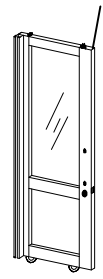
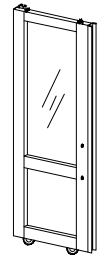
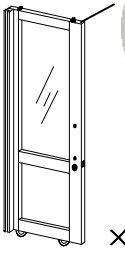

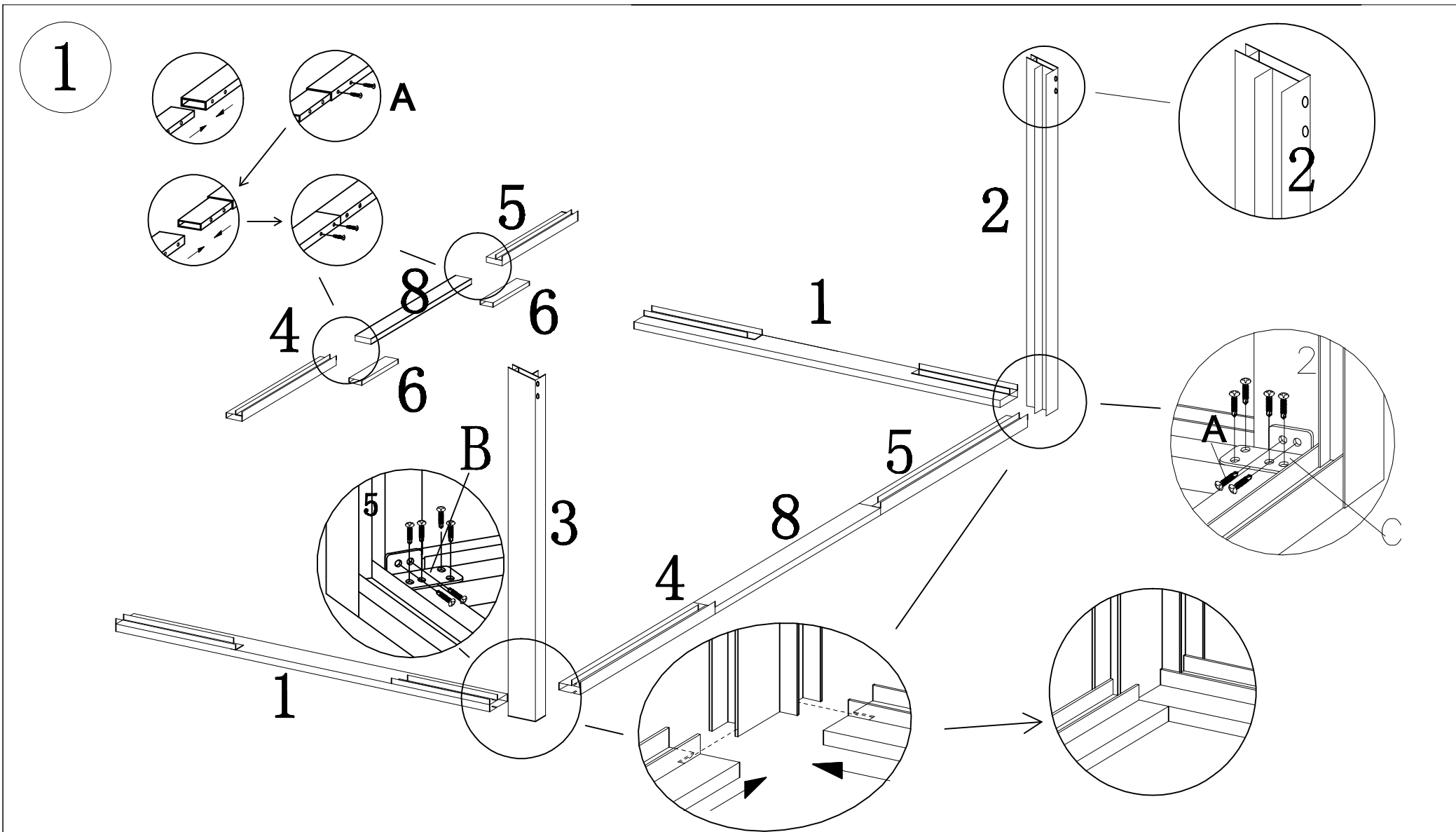
5.1X2.9M exploded view

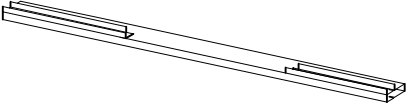
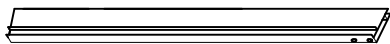
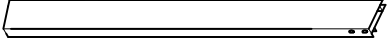
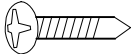



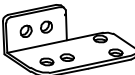
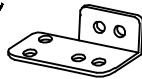



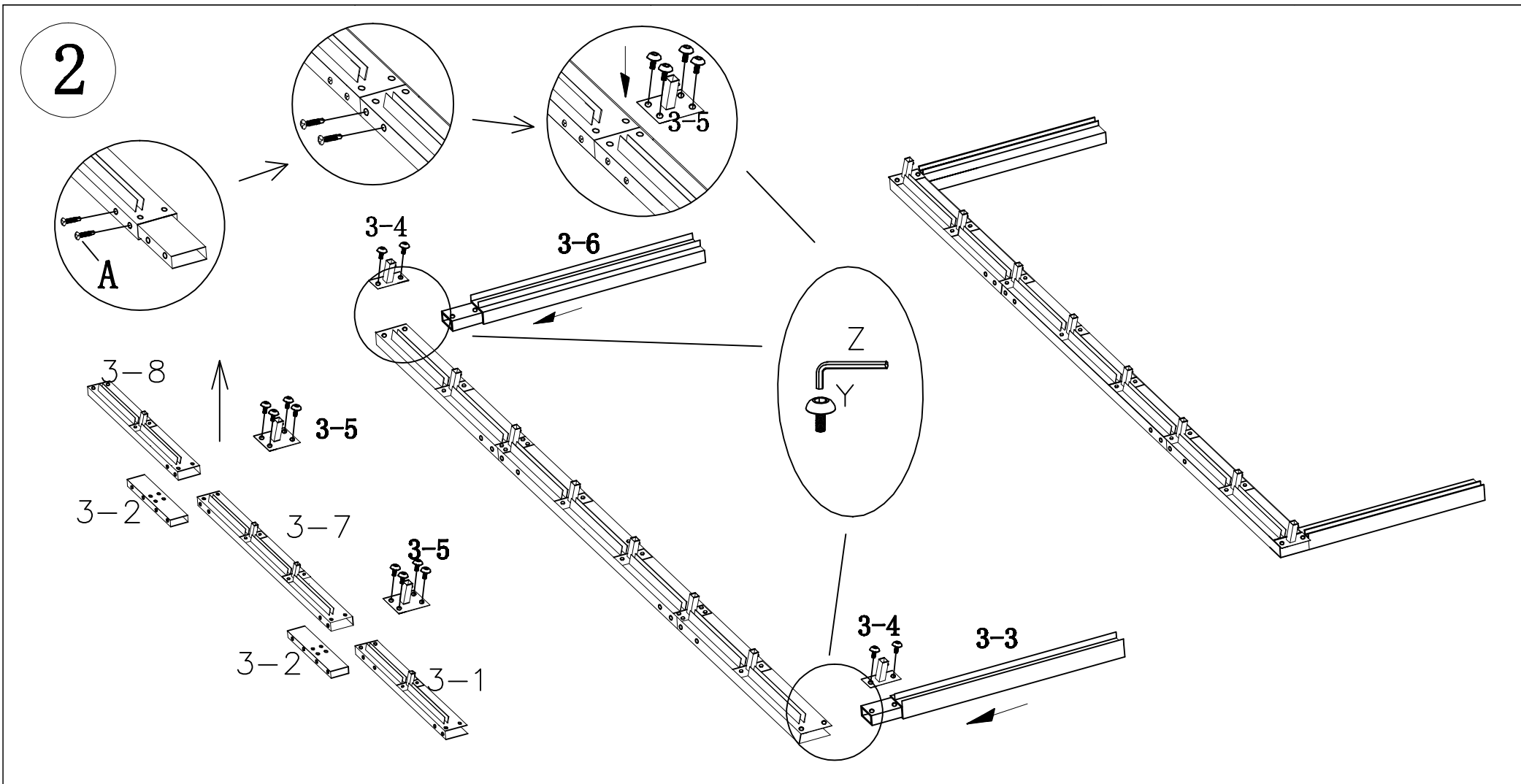

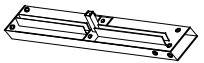
1	 x2	3-8	 x1	21-2	 x3	23	 x2	29	 x2	M	 x1				
2	 x1	4	 x2	21-3	 x3	24	 x2	30	 x7	N	 x1				
2-1	 x1	5	 x2	22	 x2	25	 x2	31	 x14	O	 x2				
2-2	 x1	6	 x4	27	 x2	H	 x3	A	 x320	P	 x8				
2-3	 x1	7	 x2	B	 x2	C	 x2	G	 x29	F	 x12				
2-4	 x1	8	 x2	I	 x10	J	 x1	K	 x6	Q1	 x6				
3	 x1	12	 x2	Y	 x22	Z	 x2	26	 x60M	Q	 x6				
3-1	 x1	13	 x2	33	 5M x1	32	 x50	X	 x6	W	 POLYCARBONATE x14				
3-2	 x2	14	 x2	T	 x2	V	 x2	R	 x2	R1	 x1	R2	 x1		
3-3	 x1	15	 x2	D	 x2	D1	 x2	D2	 x2	D3	 x2	R3	 x1	R4	 x1
3-4	 x2	16	 x2	D	 x2	D1	 x2	D2	 x2	D3	 x2	R3	 x1	R4	 x1
3-5	 x2	18	 x6	D	 x2	D1	 x2	D2	 x2	D3	 x2	R3	 x1	R4	 x1
3-6	 x1	19	 x7	D	 x2	D1	 x2	D2	 x2	D3	 x2	R3	 x1	R4	 x1
3-7	 x1	28	 x2	D	 x2	D1	 x2	D2	 x2	D3	 x2	R3	 x1	R4	 x1

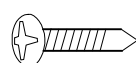
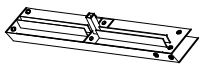

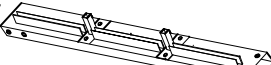
<p>1</p>  <p>x2</p>	<p>2</p>  <p>x1</p>	<p>3</p>  <p>x1</p>	<p>A</p>  <p>x20</p>	
<p>4</p>  <p>x1</p>	<p>5</p>  <p>x1</p>	<p>8</p>  <p>x1</p>	<p>B</p>  <p>x1</p> <p>C</p>  <p>x1</p>	<p>6</p>  <p>x2</p>

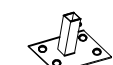



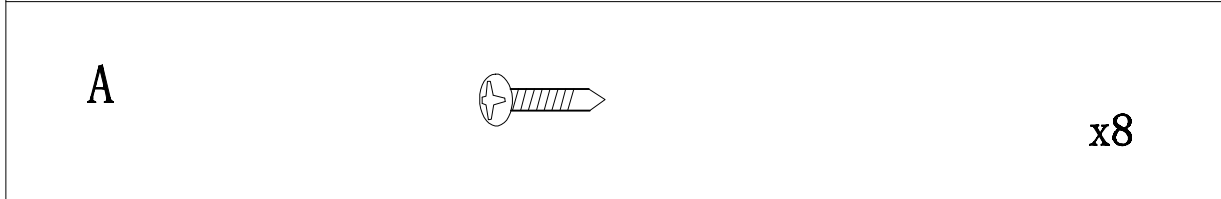
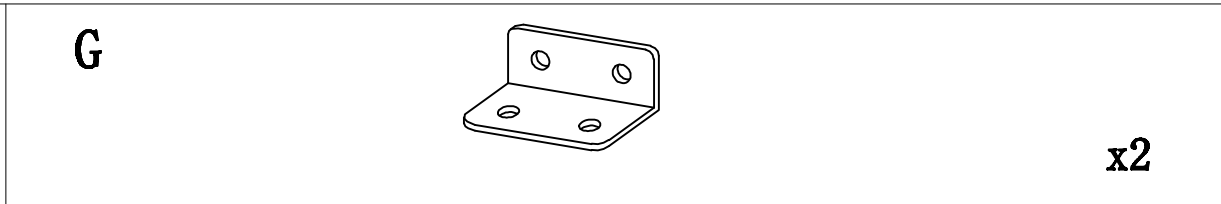
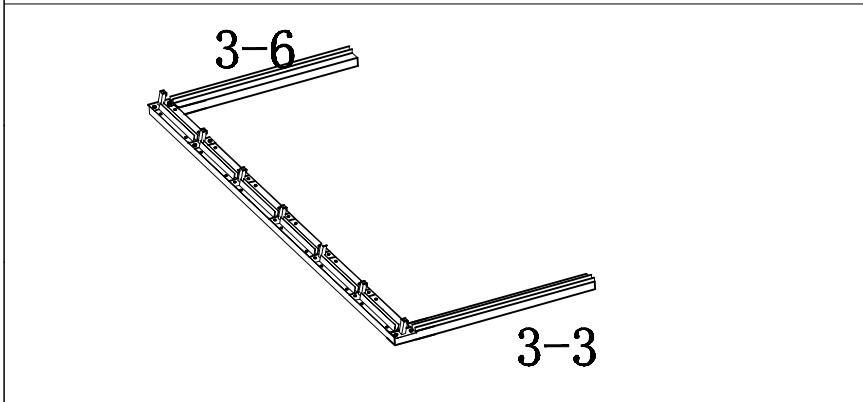
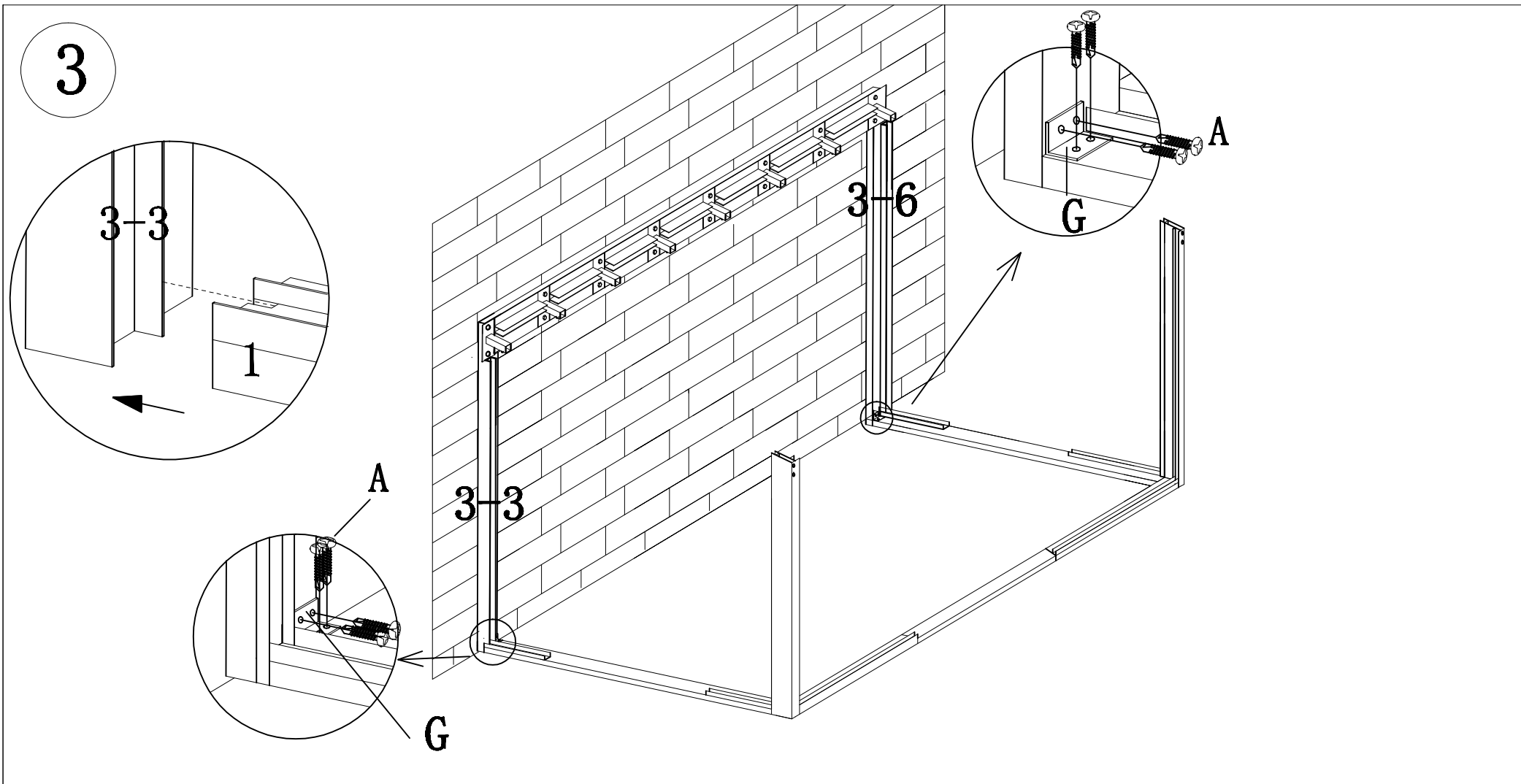

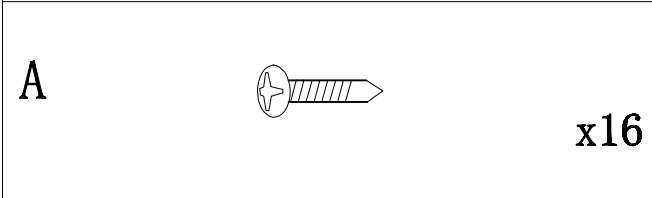
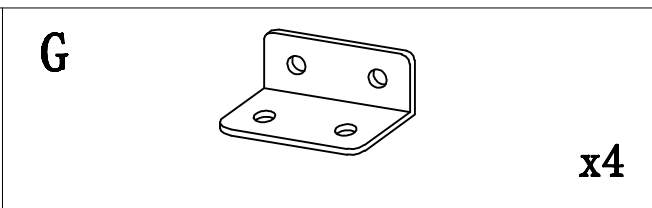
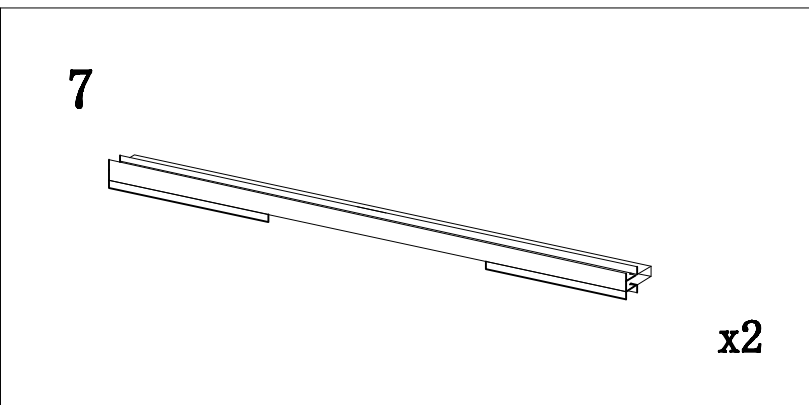
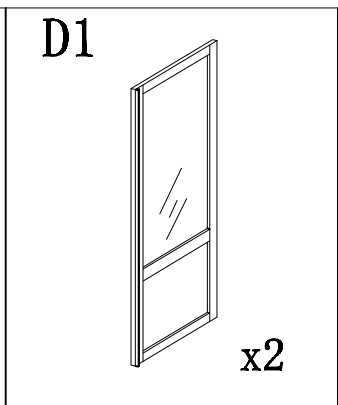
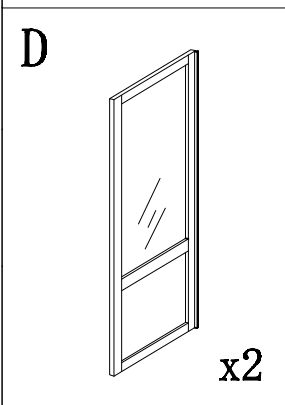
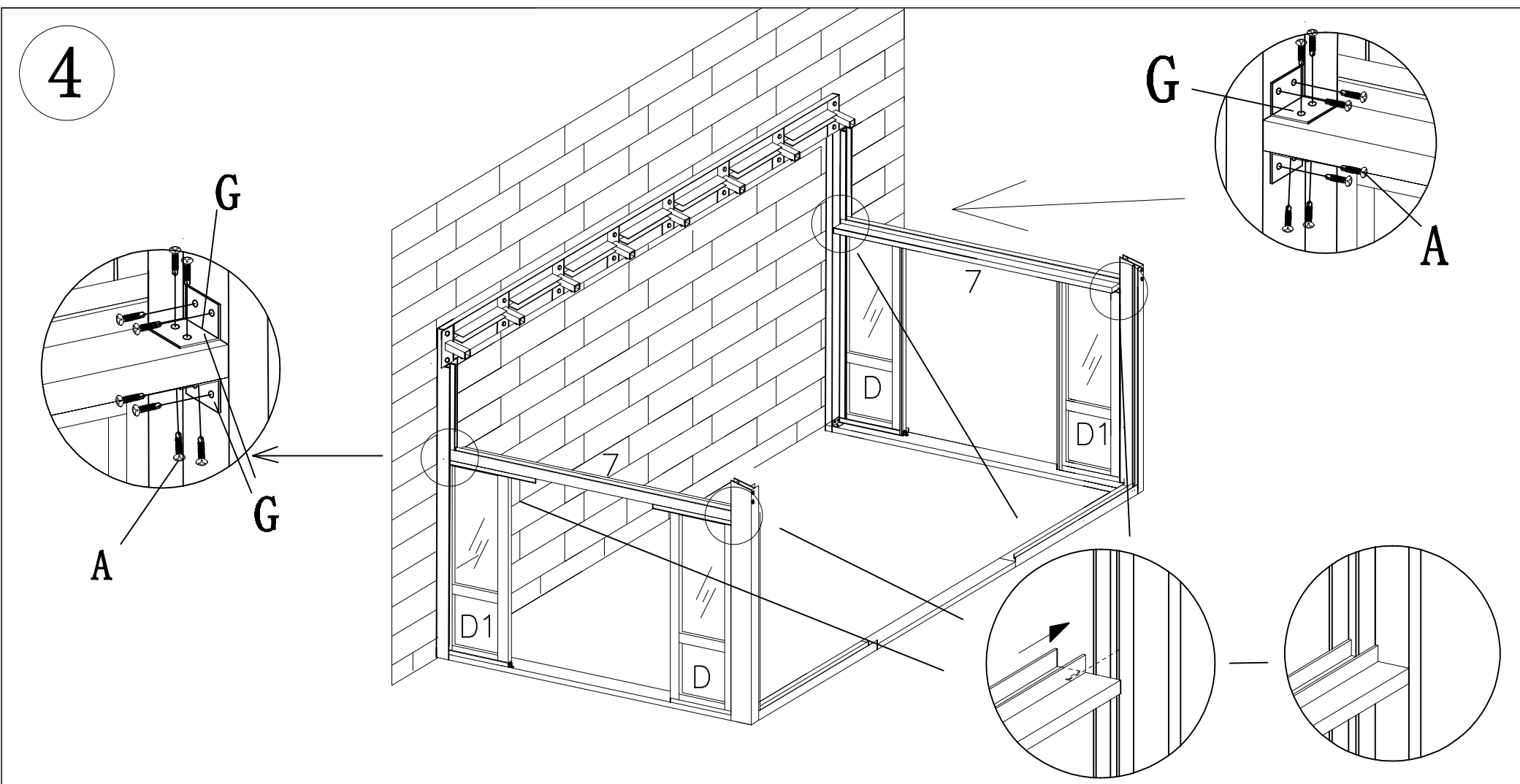

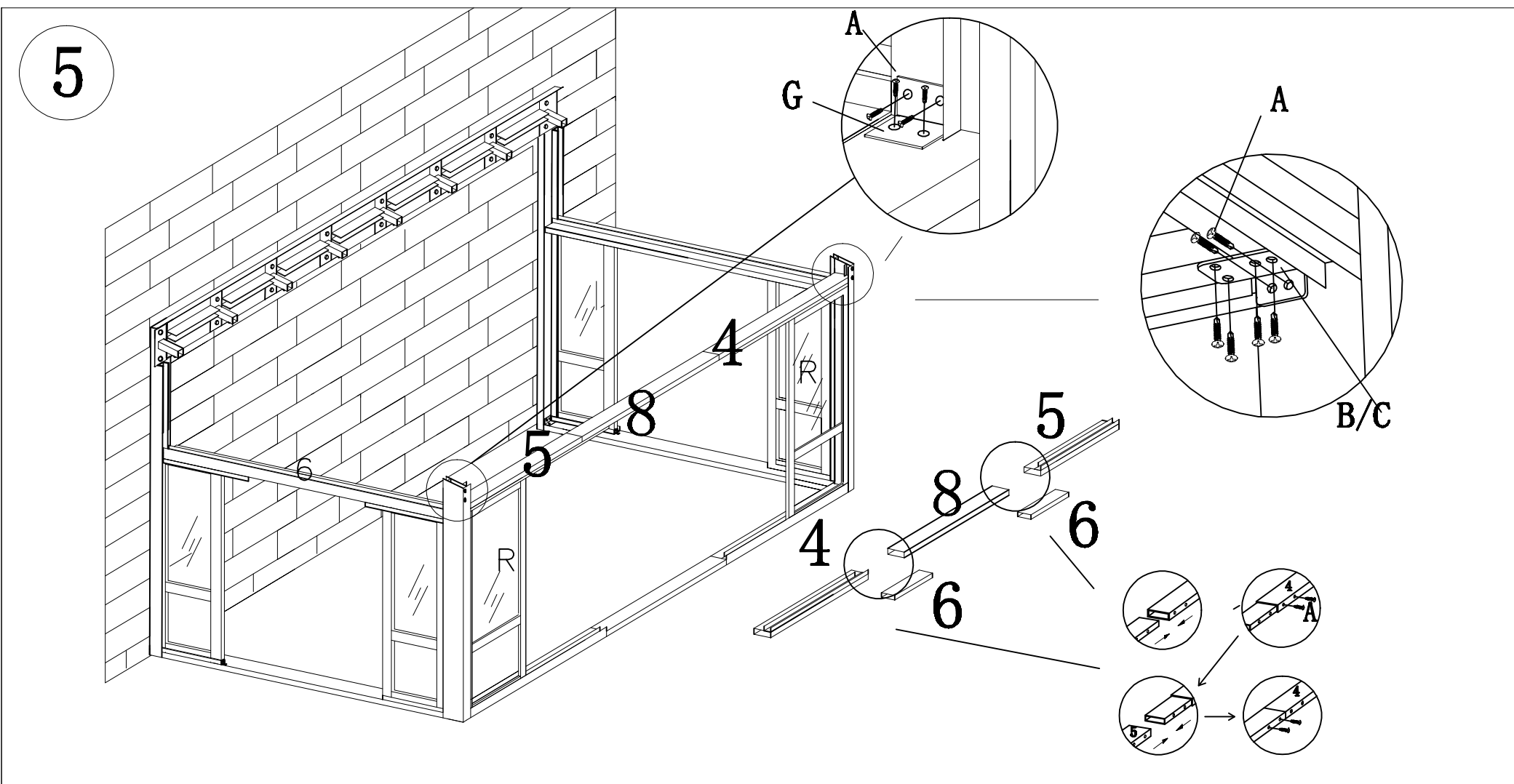
3-8  x1	3-3  x1	3-6  x1	A  x8
3-1  x1	3-4  x2	3-7  x1	Z  x2
3-2  x2	3-5  x2	Y  x12	

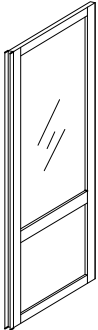

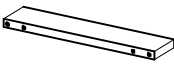

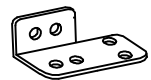
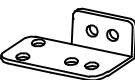

 <p>R</p> <p>x2</p>	 <p>4</p> <p>x1</p>	 <p>5</p> <p>x1</p>	 <p>8</p> <p>x1</p>	 <p>6</p> <p>x2</p>
	 <p>B</p> <p>x1</p>	 <p>C</p> <p>x1</p>	 <p>G</p> <p>x2</p>	 <p>A</p> <p>x28</p>

6

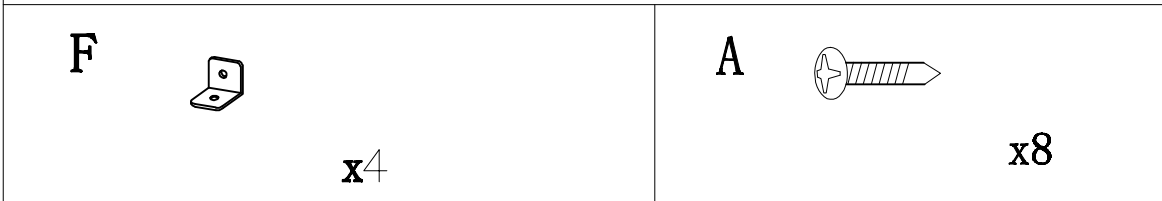
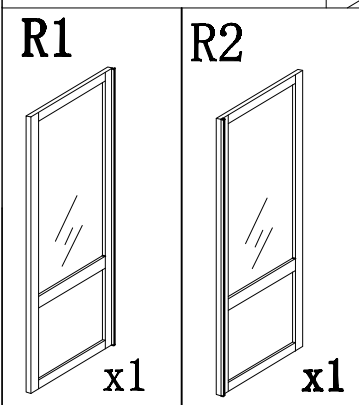
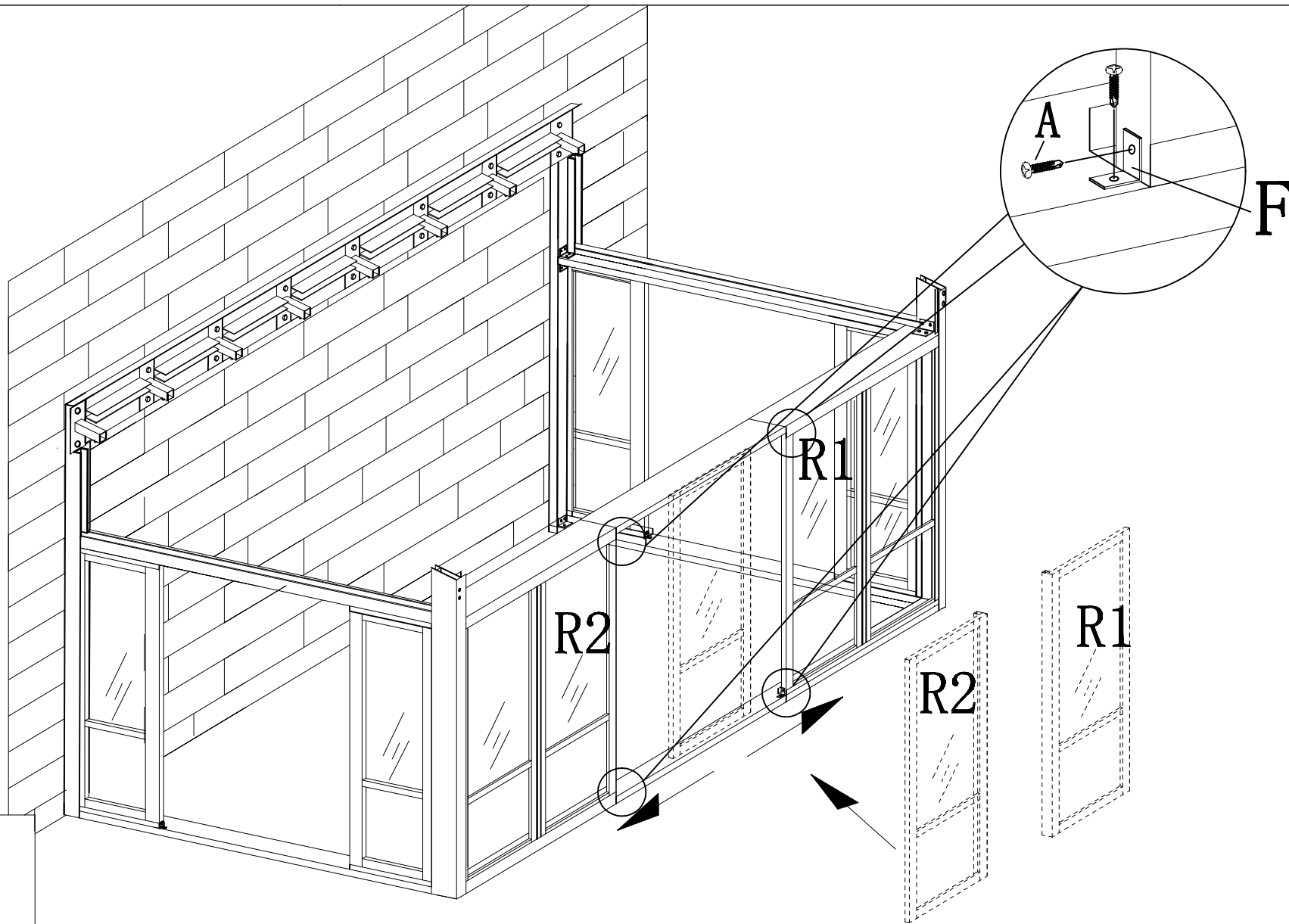

7

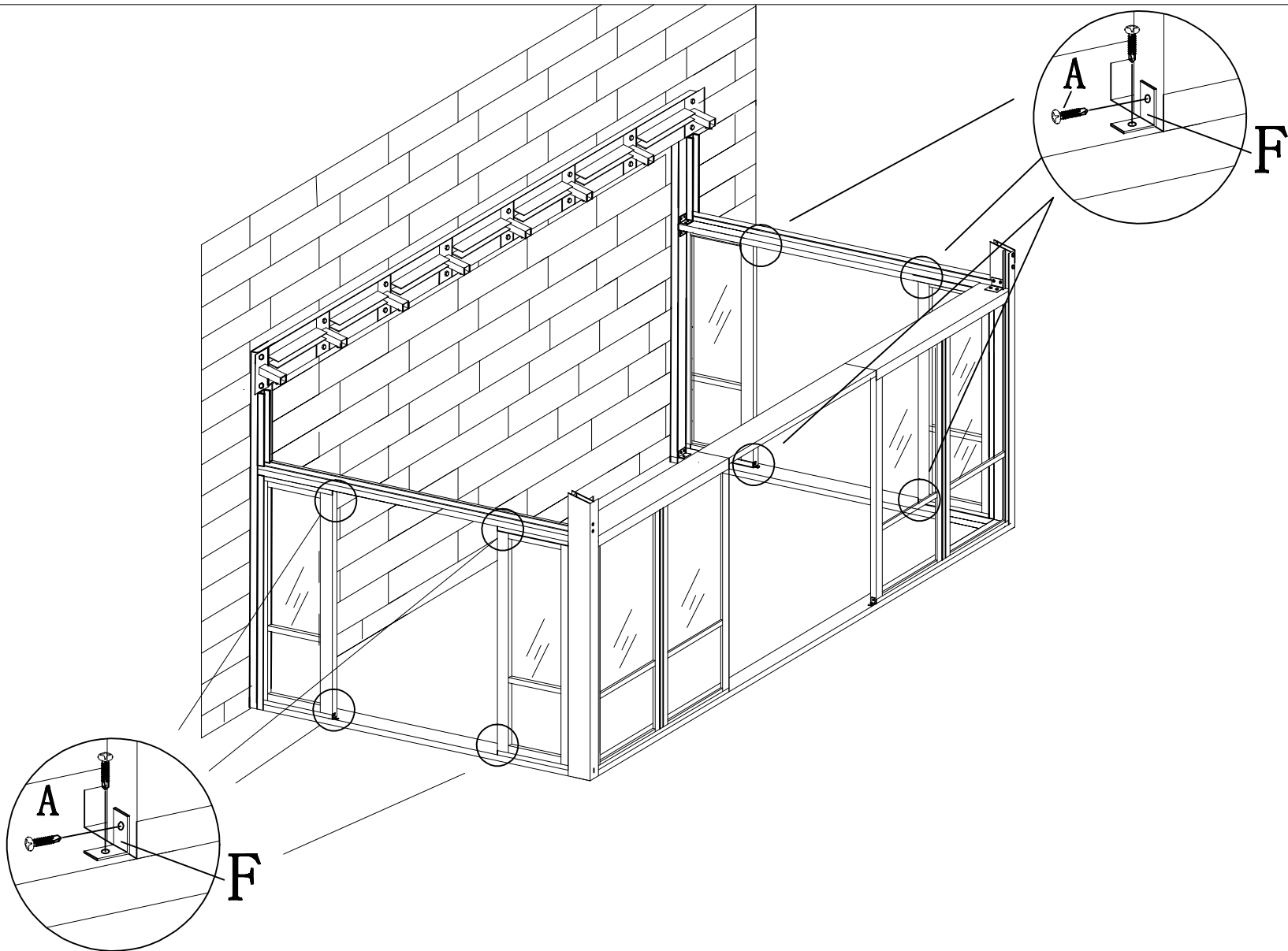

F



x8

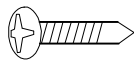

A

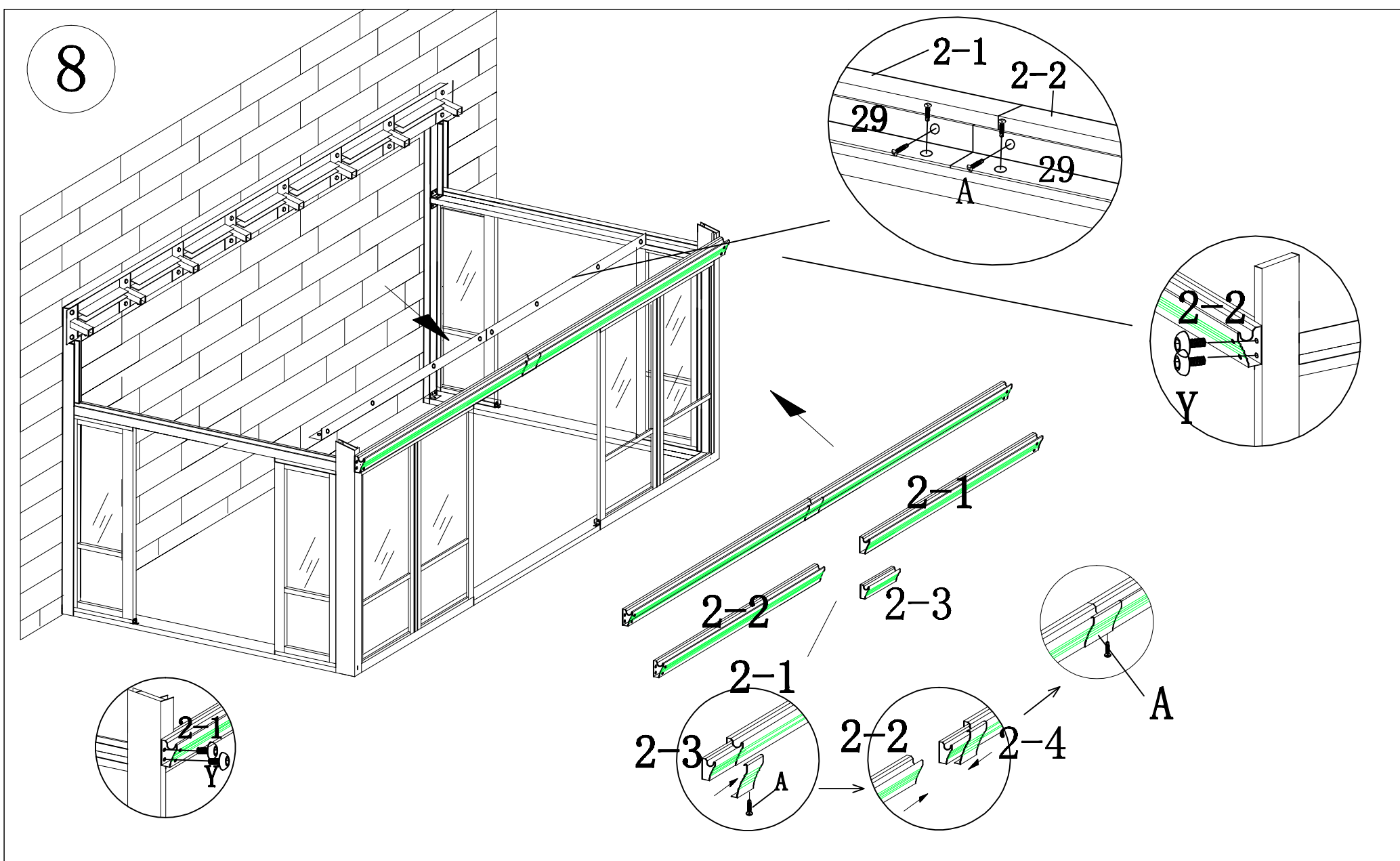

x16

8

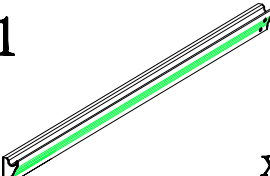
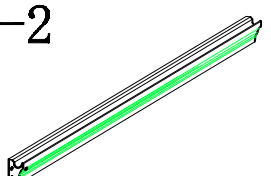
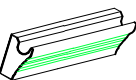

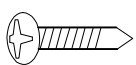
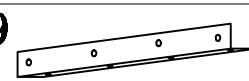
<p>2-1</p>  <p>x1</p>	<p>2-2</p>  <p>x1</p>	<p>2-3</p>  <p>x1</p>	<p>2-4</p>  <p>x1</p>	<p>Y</p>  <p>x4</p>	<p>A</p>  <p>x12</p> <p>29</p>  <p>x2</p>
--	--	---	--	--	---

9

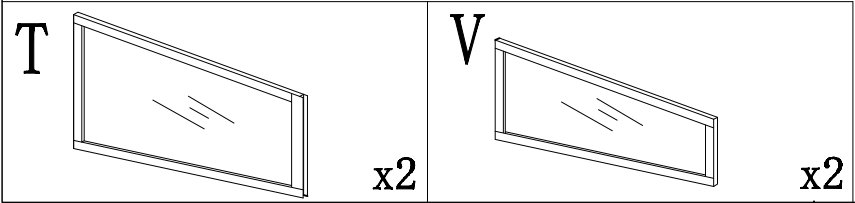
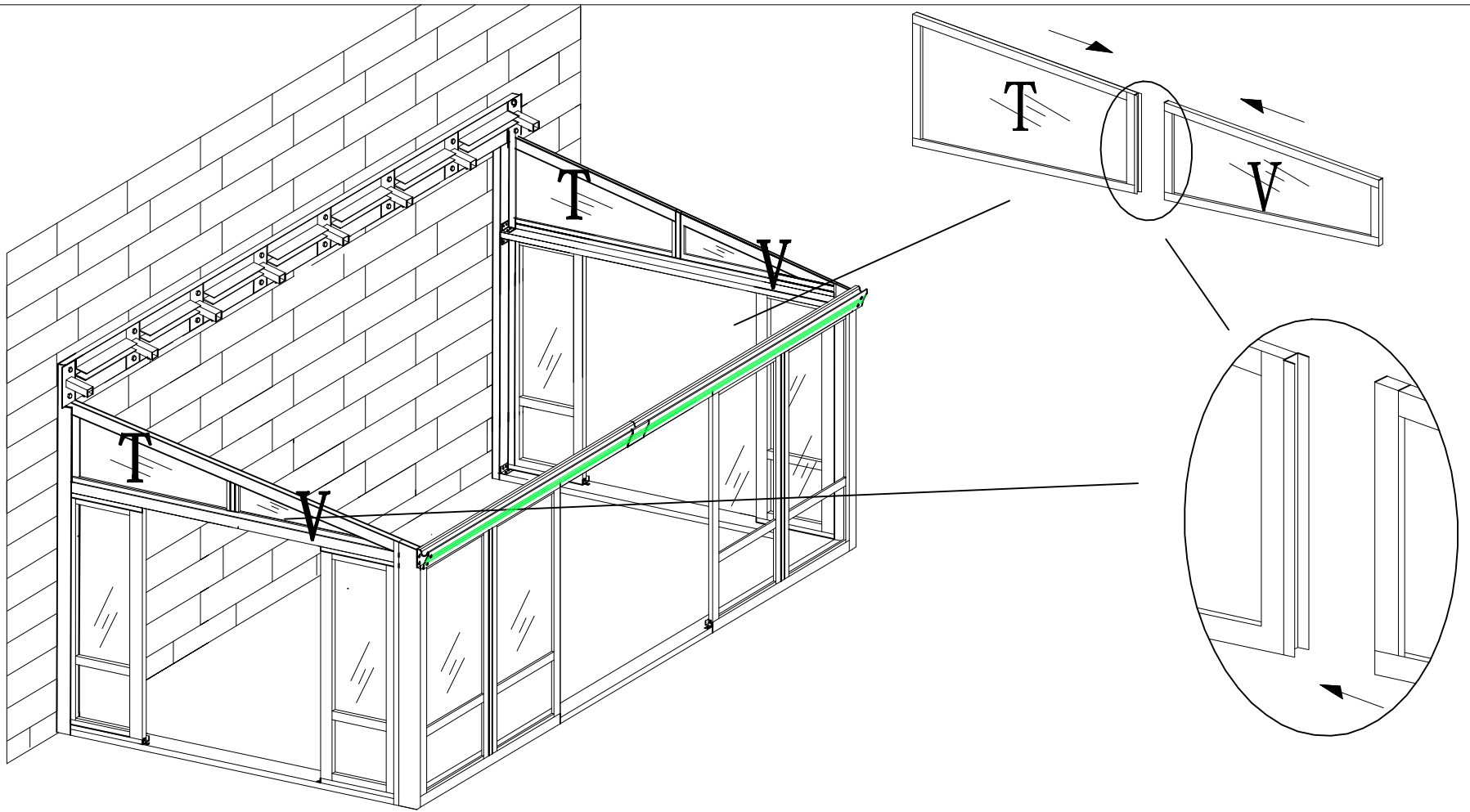

10

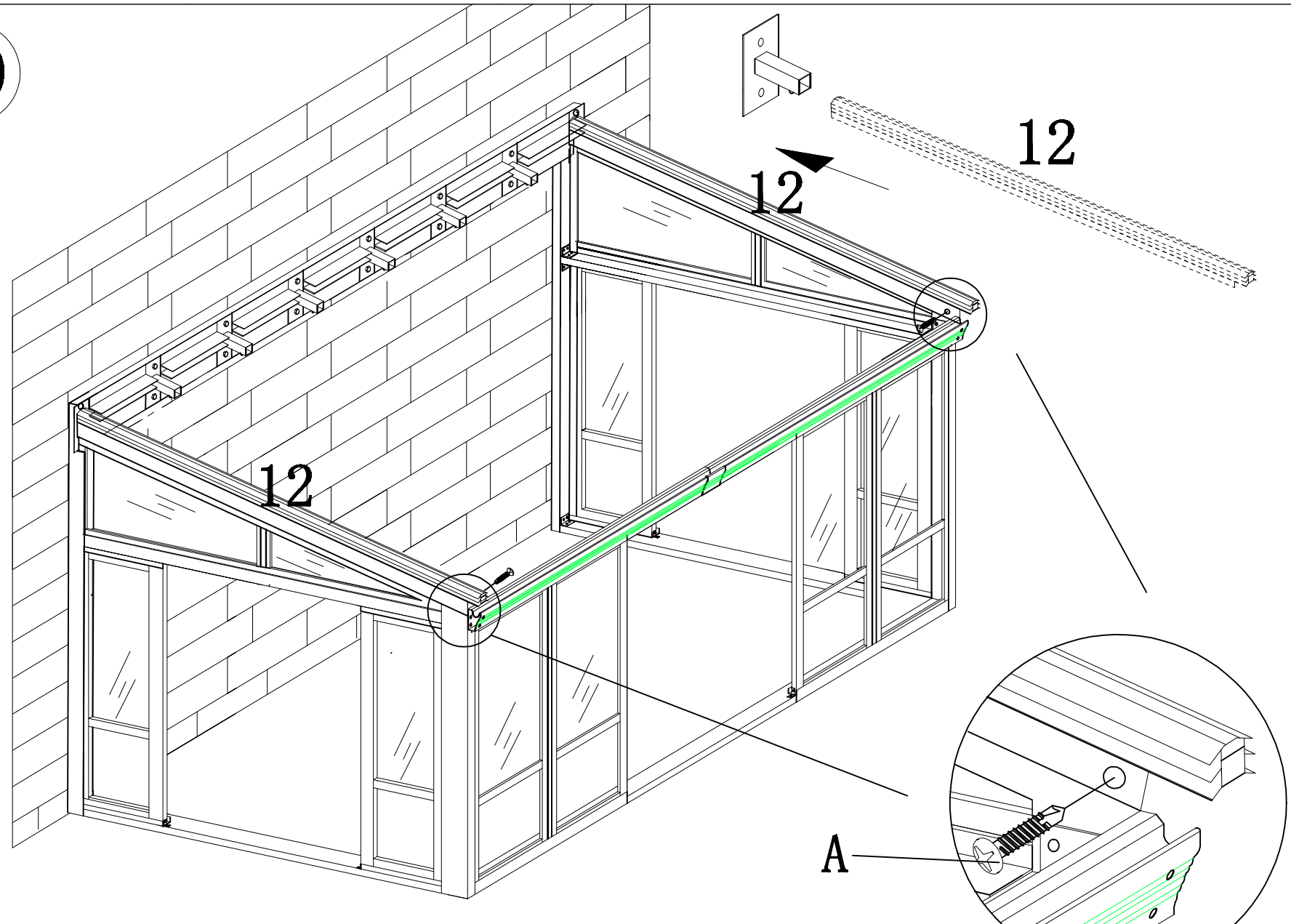

12

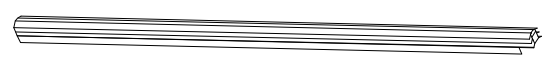

x2

A

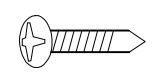

x2

11

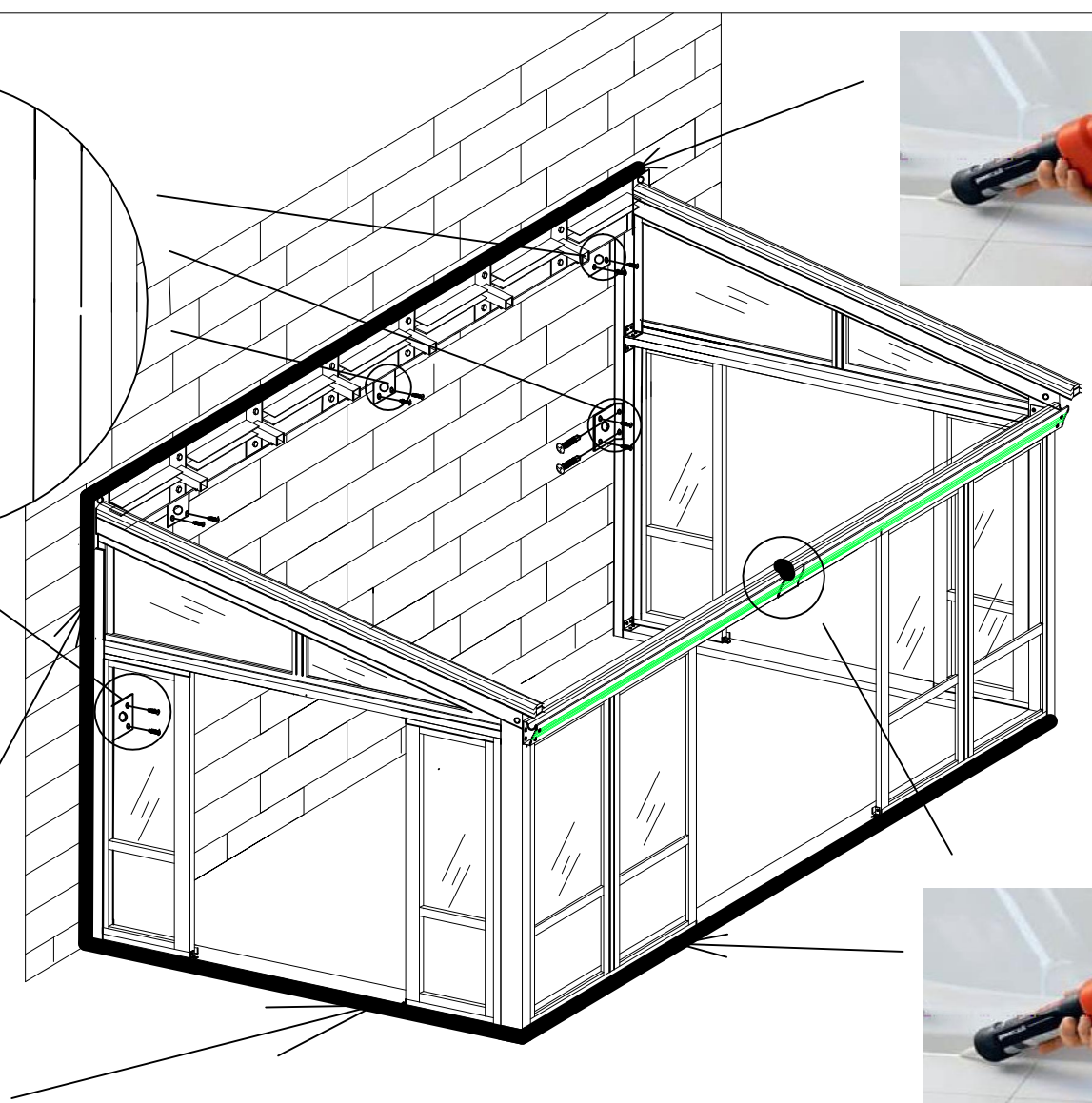
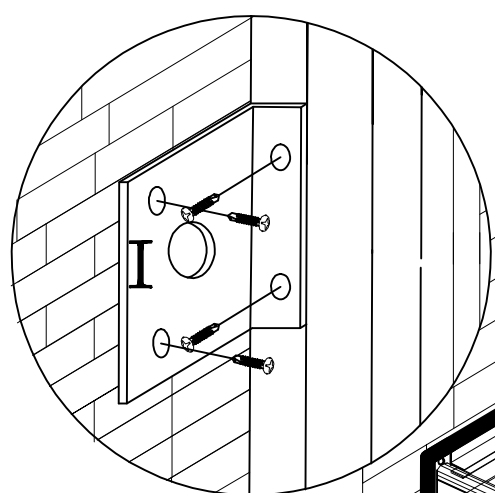

Please reinforce with glass glue on the wall, glass glue is not including.

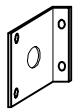
I  x10

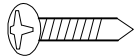
A  x40

12

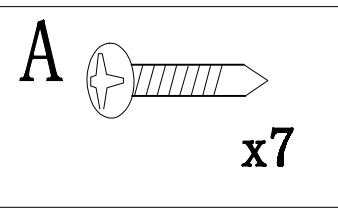
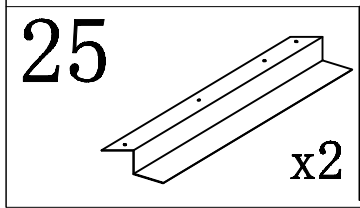
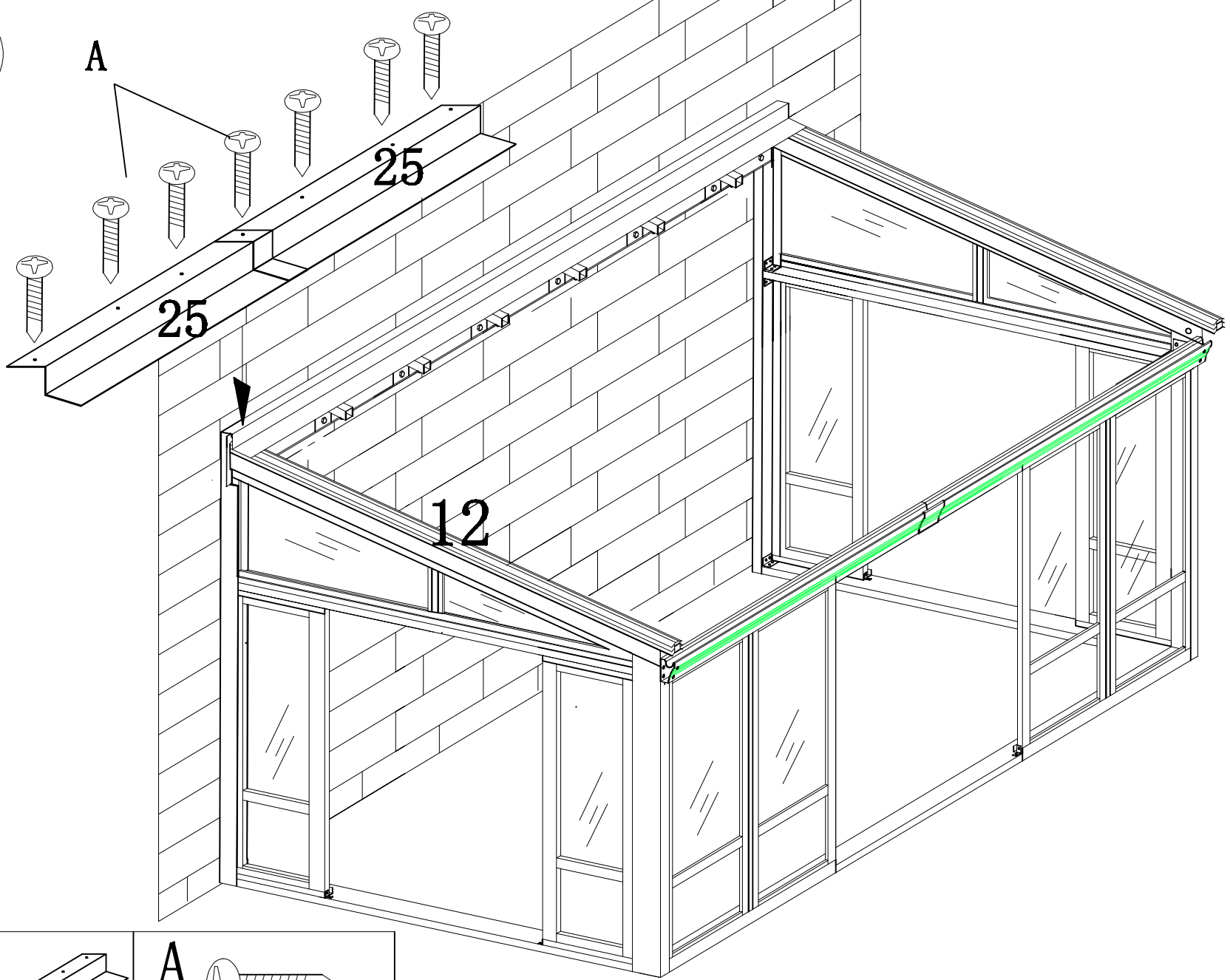

13

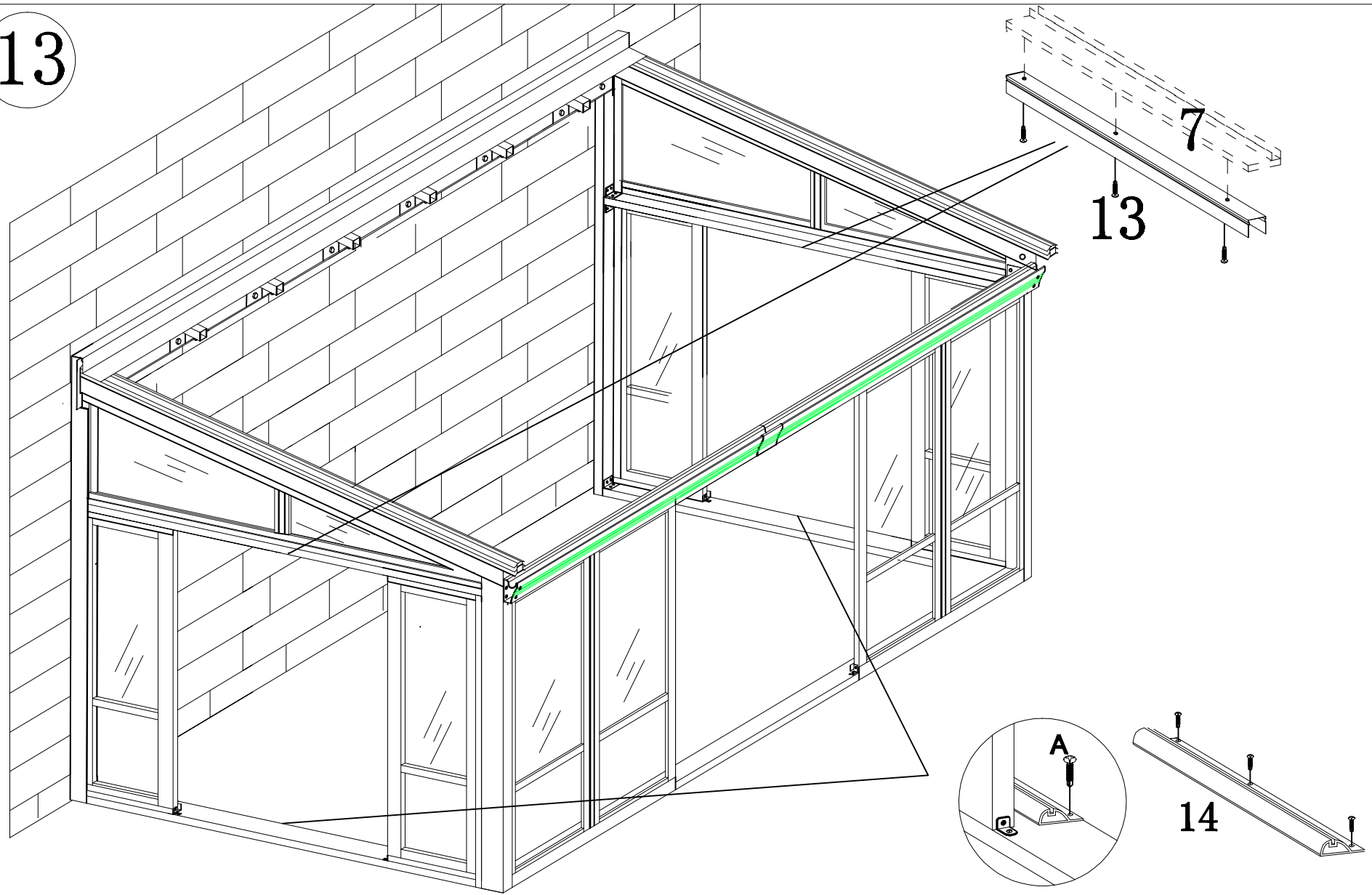

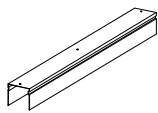
13  x2

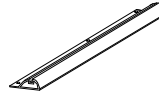
14  x2

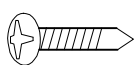
A  x12

14

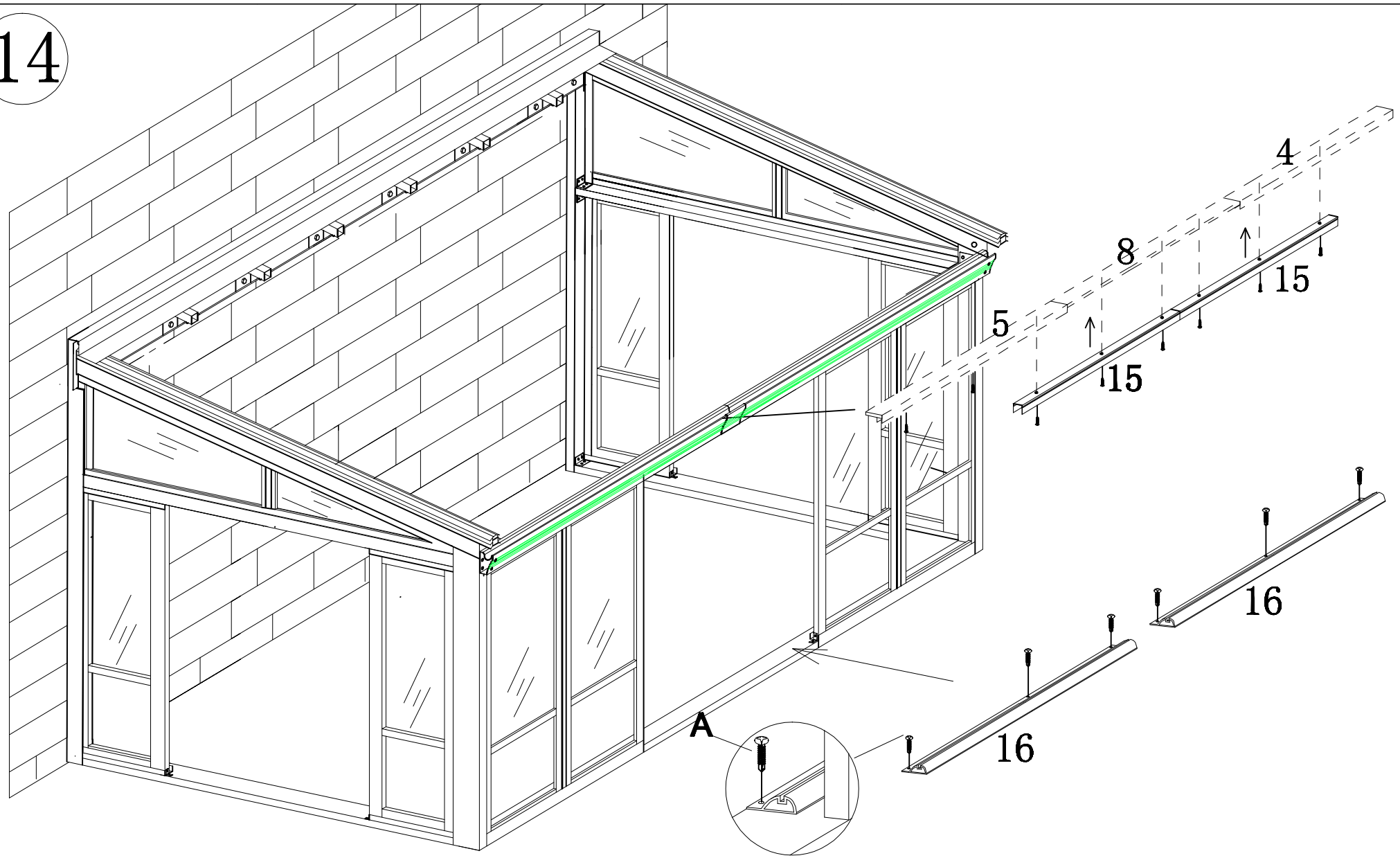

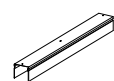
15  x2

16  x2

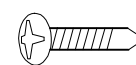
A  x12

15

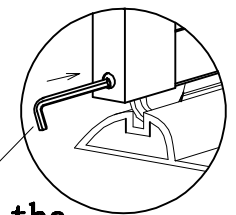
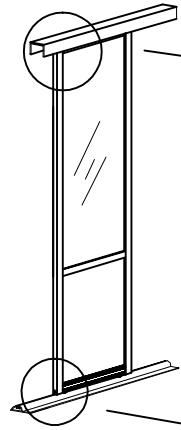
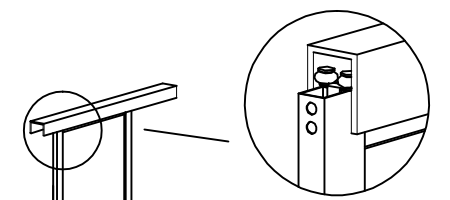
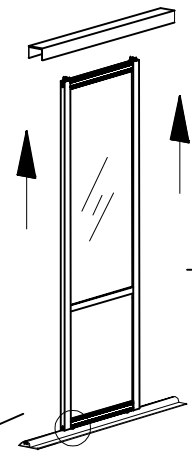
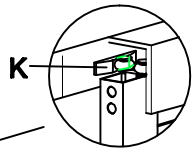
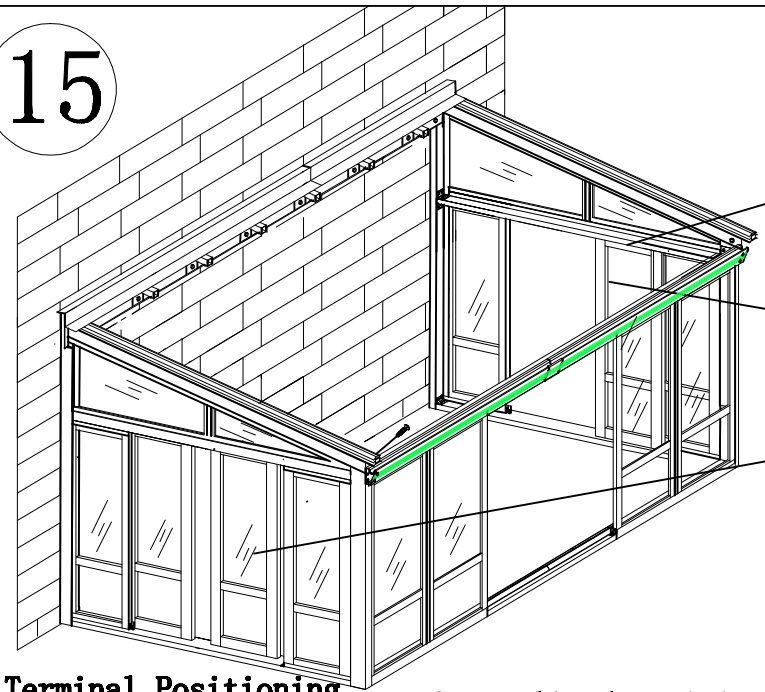

The height of the door can be adjusted here

Terminal Positioning

Centralized Positioning

Terminal Positioning

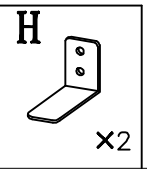
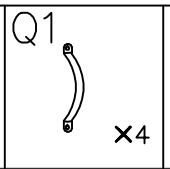
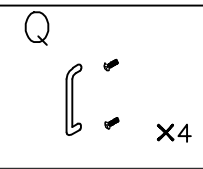
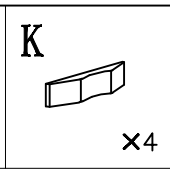
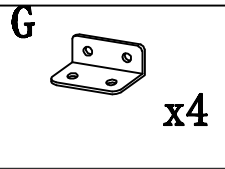
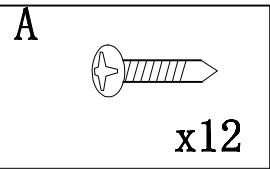
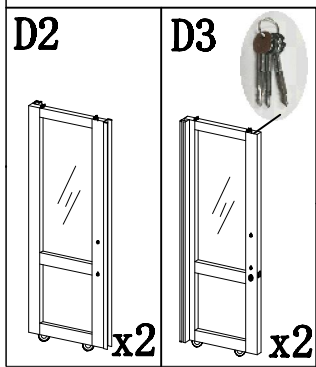
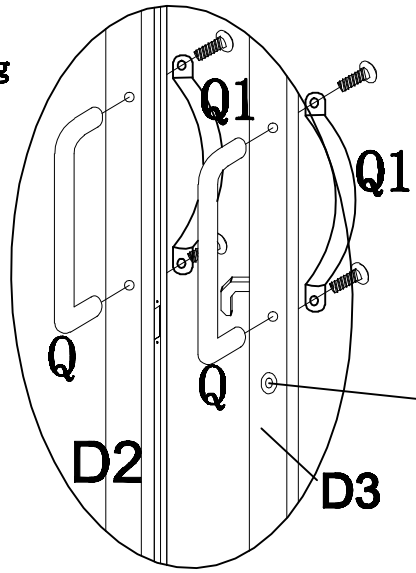
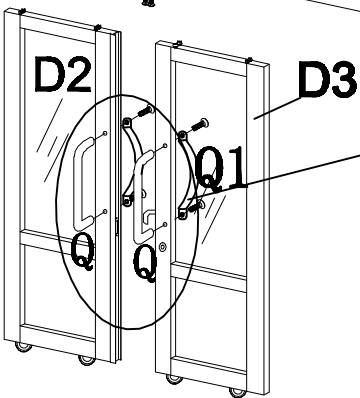
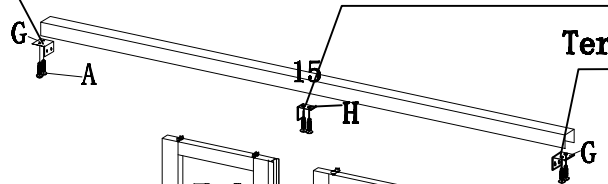

16

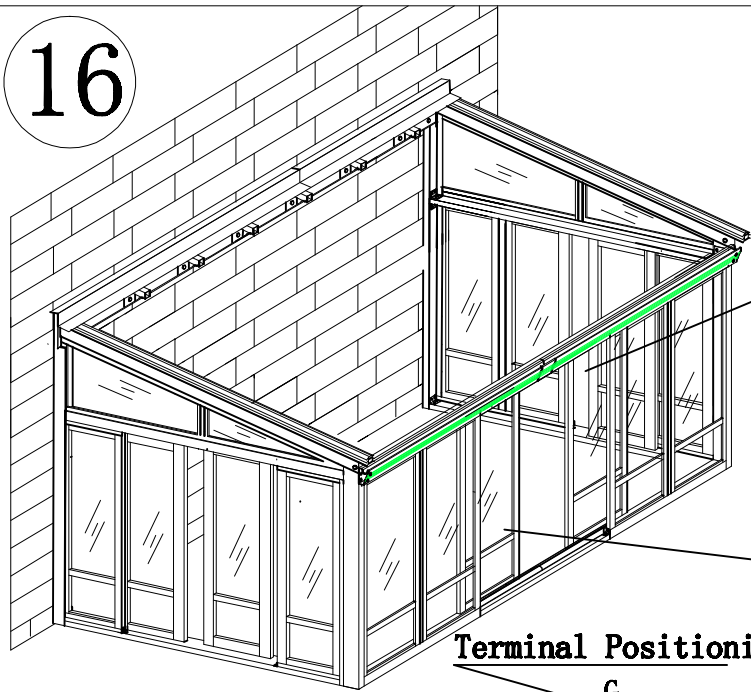

Terminal Positioning





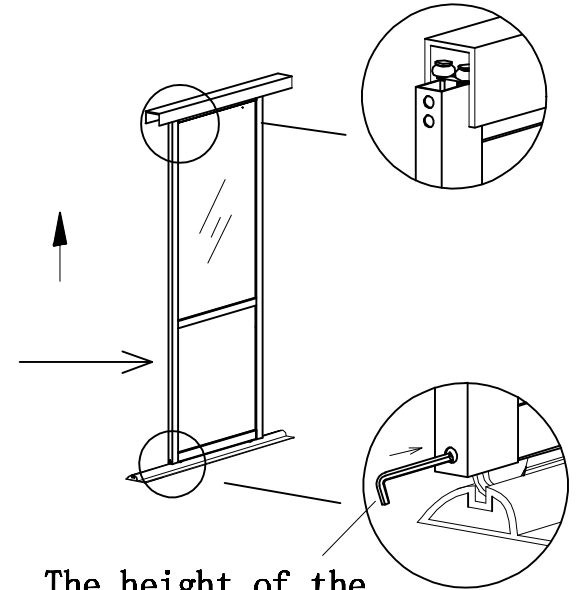
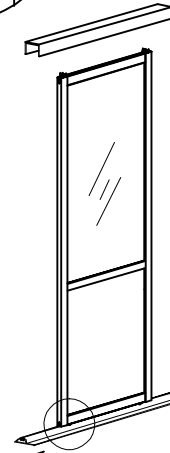
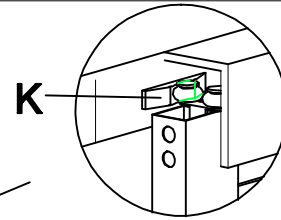
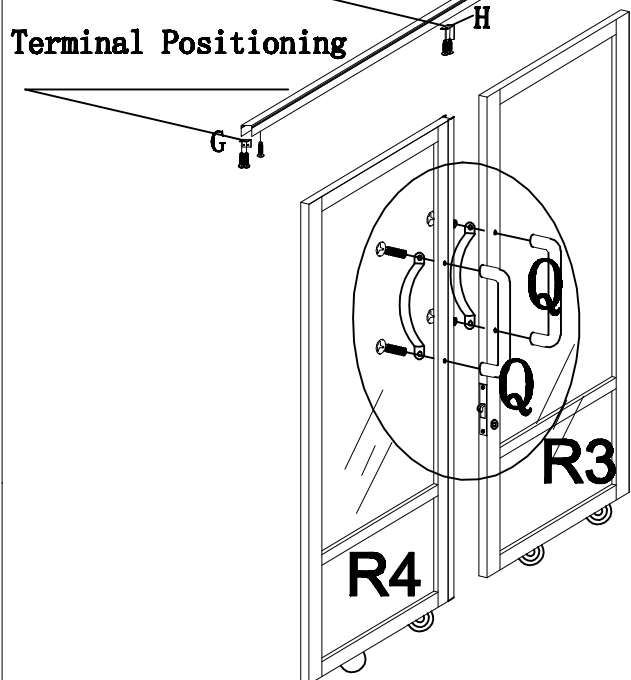

Centralized Positioning

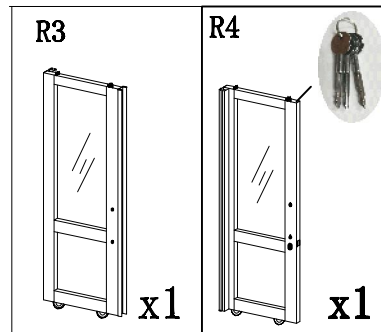
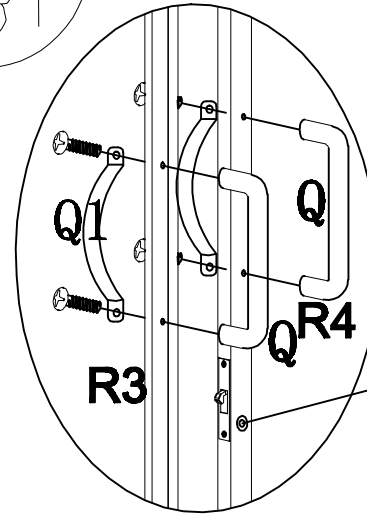
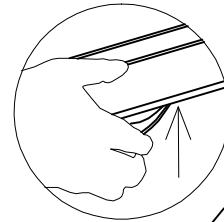
Terminal Positioning

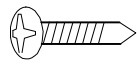

The height of the door can be adjusted here



<p>A</p>  <p>x6</p>	<p>G</p>  <p>x3</p>	<p>Q</p>  <p>x2</p>	<p>Q1</p>  <p>x2</p>	<p>K</p>  <p>x2</p>	<p>H</p>  <p>x2</p>
--	--	--	---	--	--

17

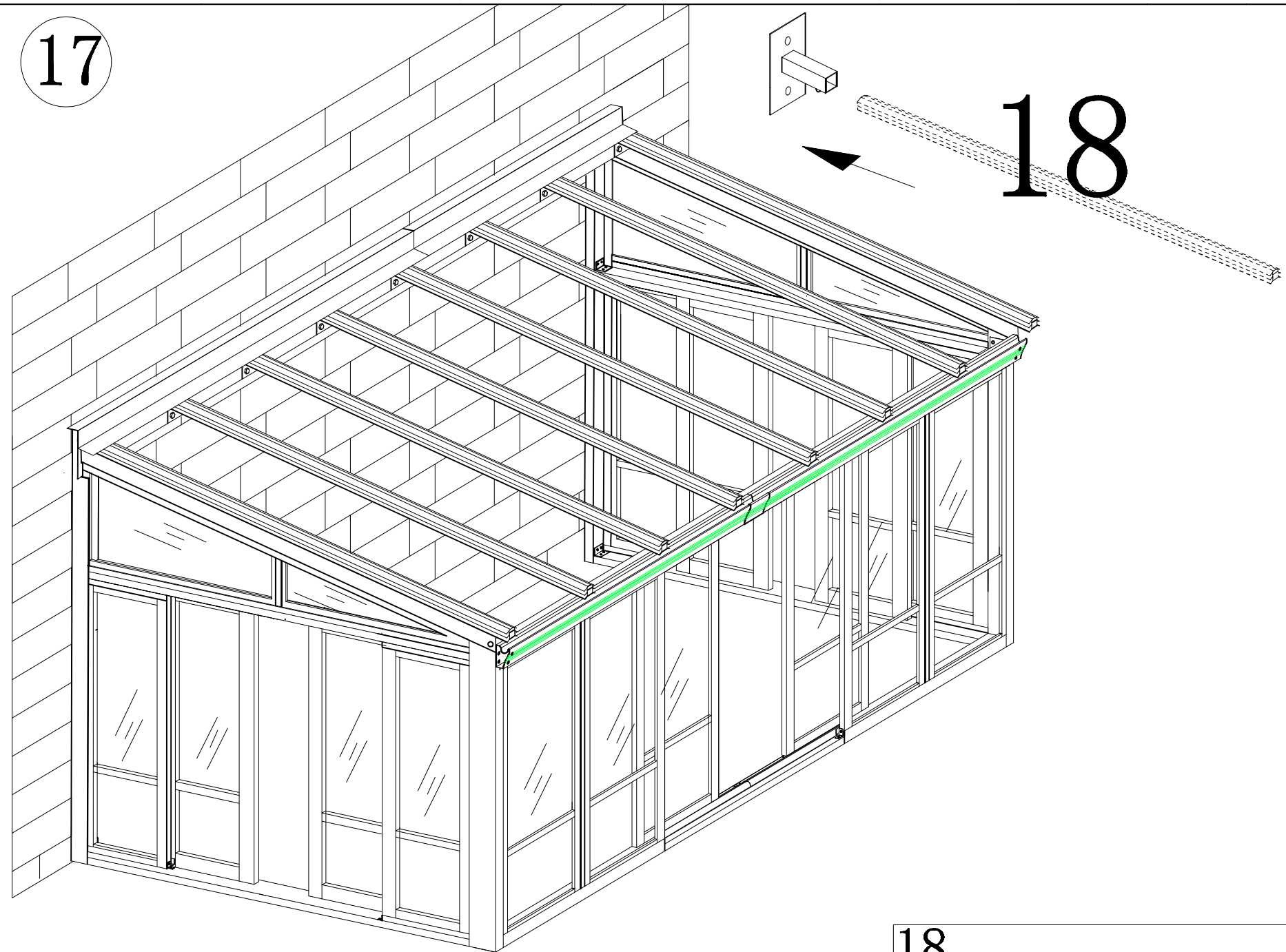

18

18



x6

18

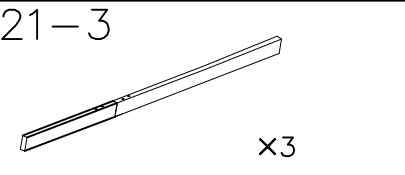
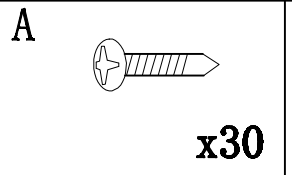
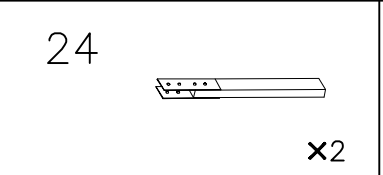
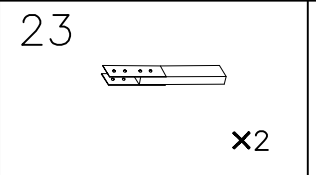
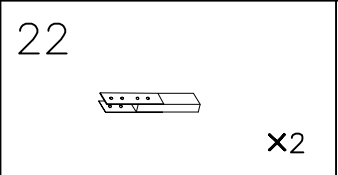
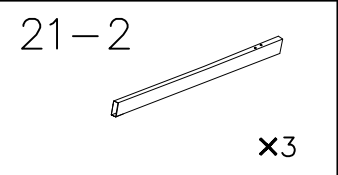
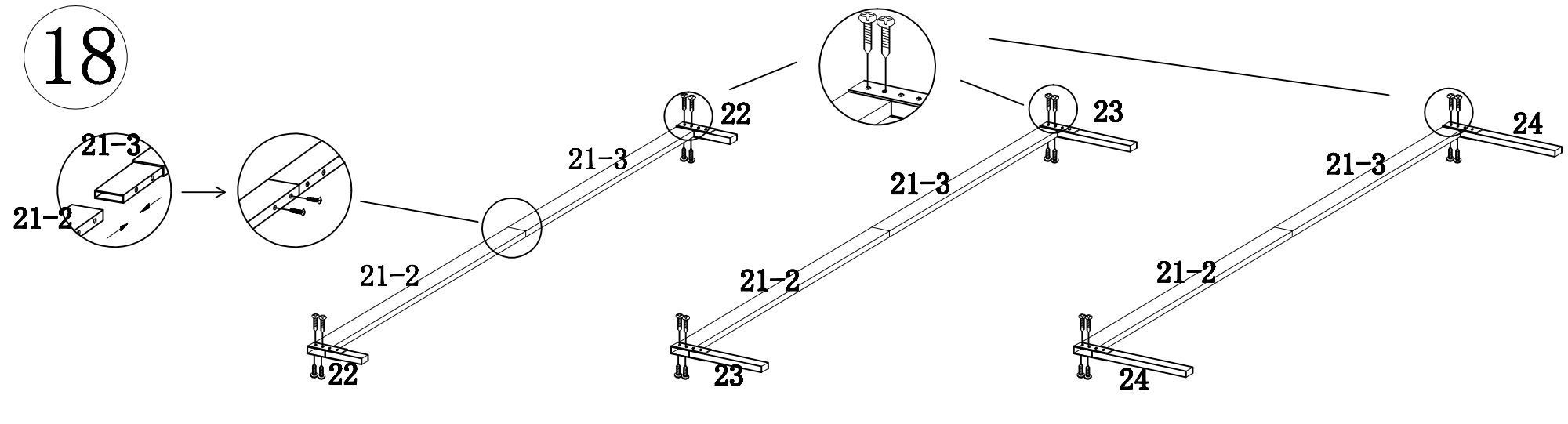

19

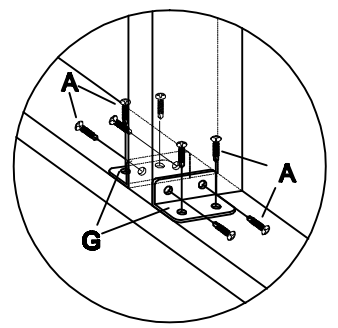
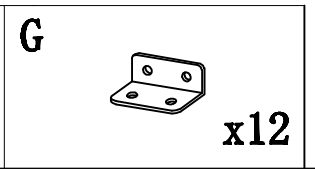
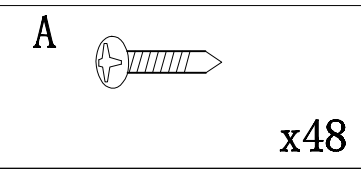
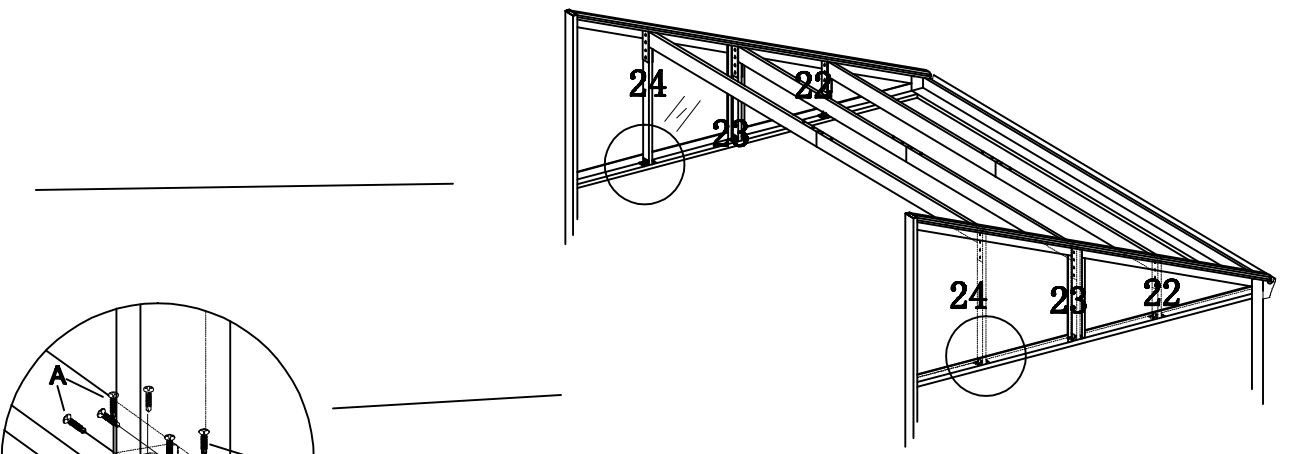
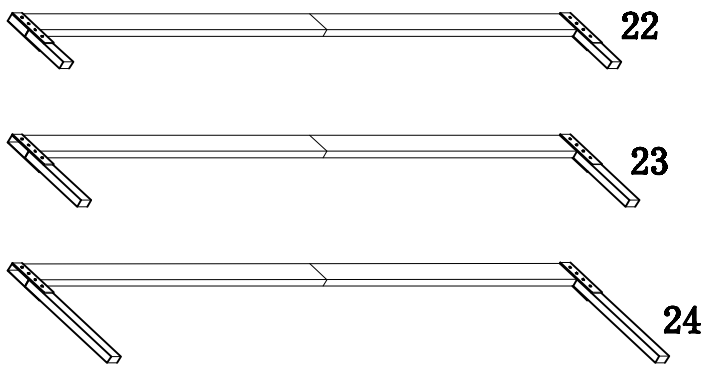

20

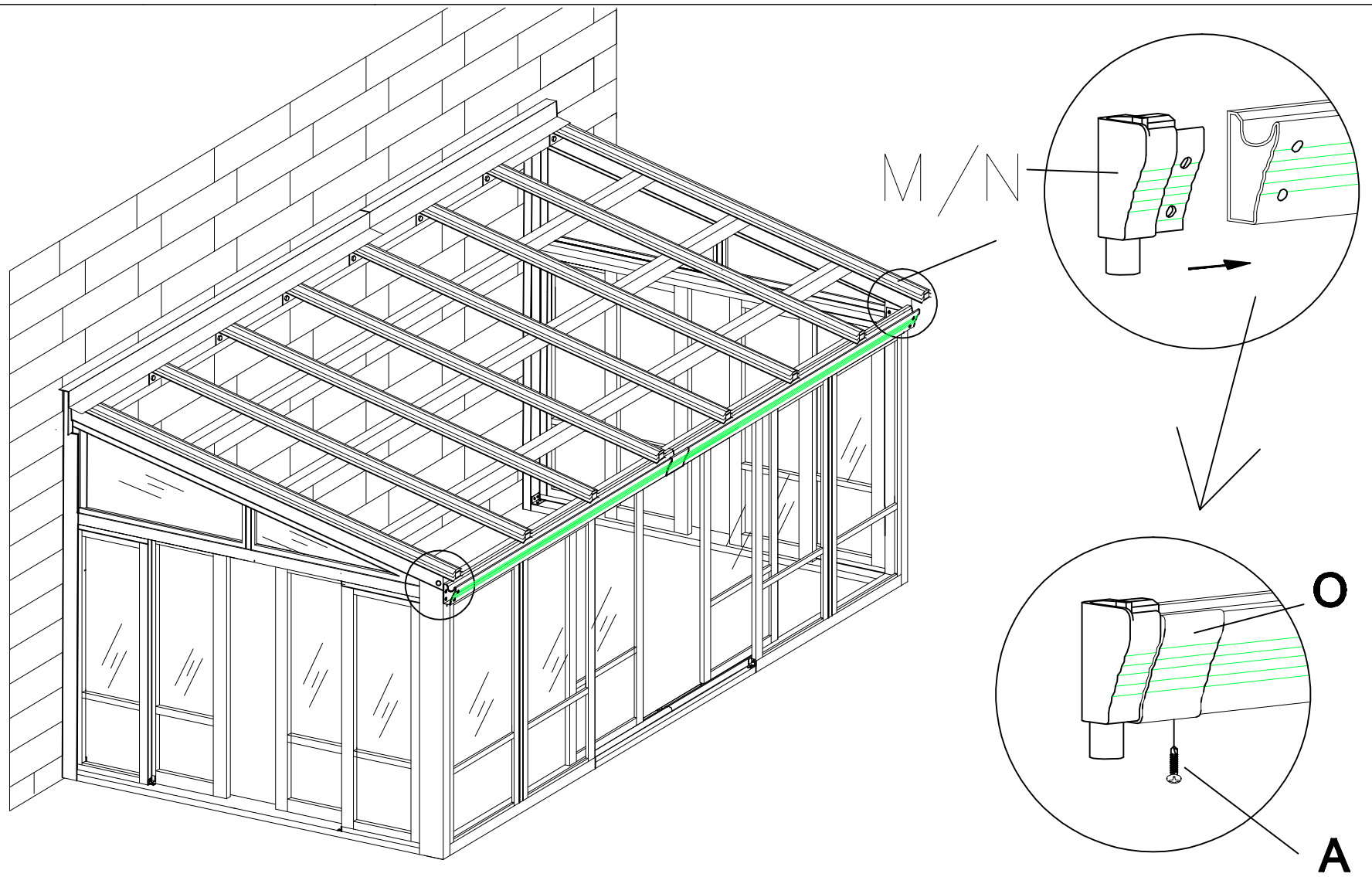

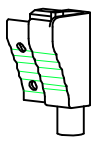
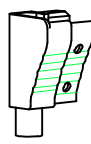
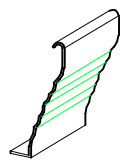
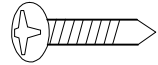
M  ×1	N  ×1	O  ×2	A  ×2
---	---	---	---

21

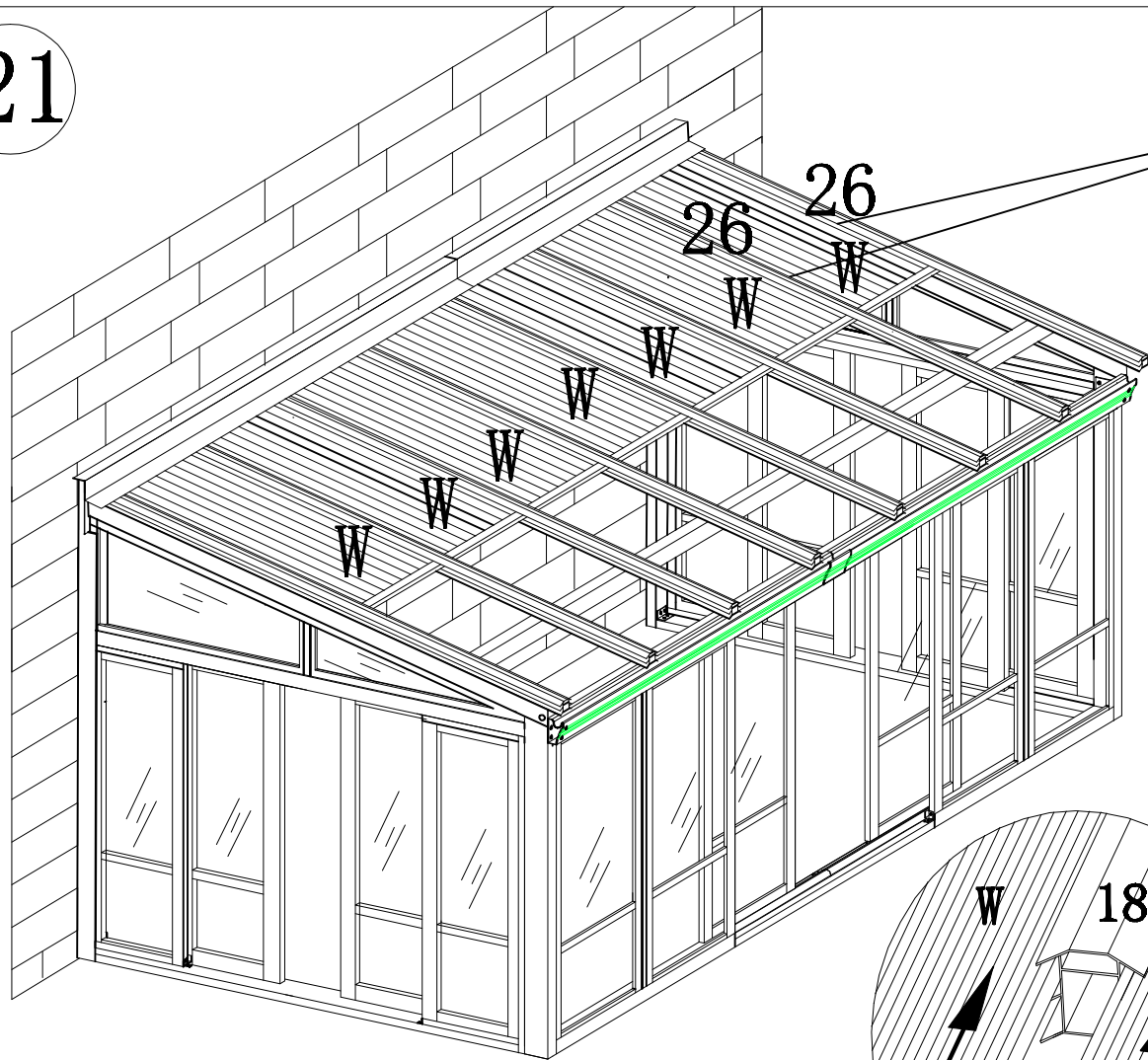

26

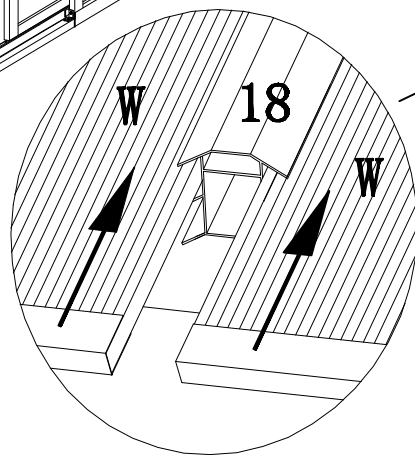
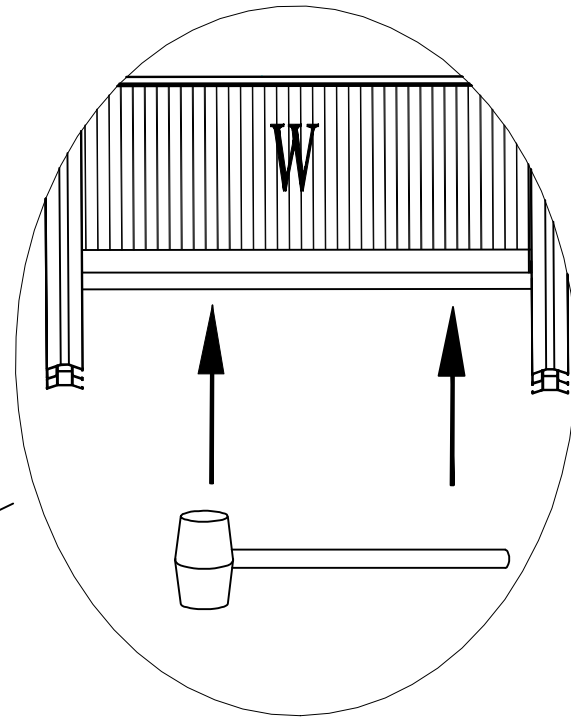





W	POLYCARBONATE	x7

26

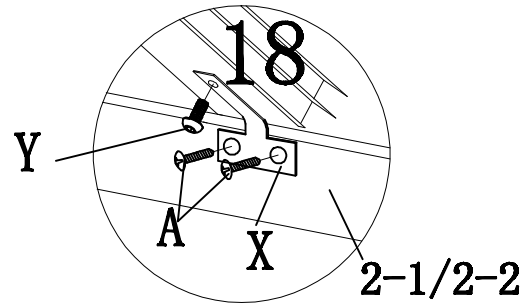
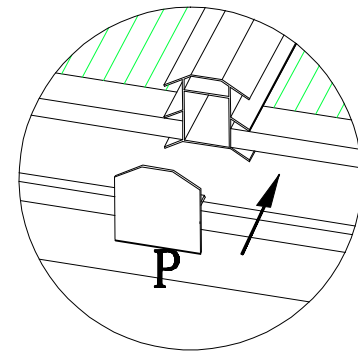
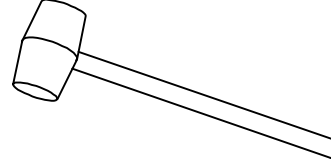
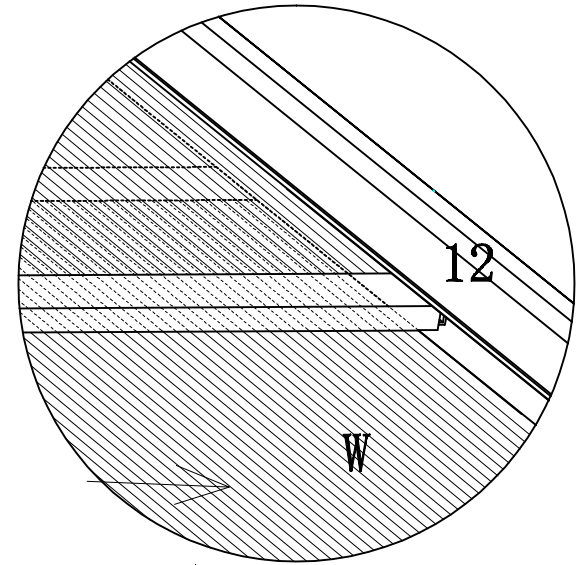
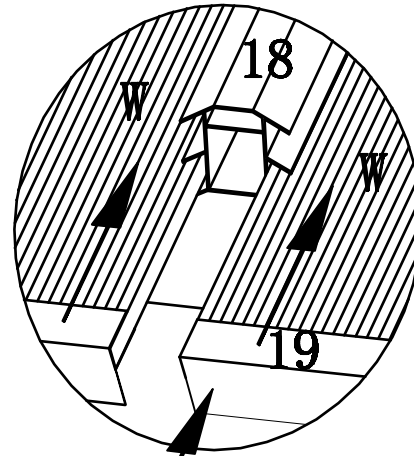
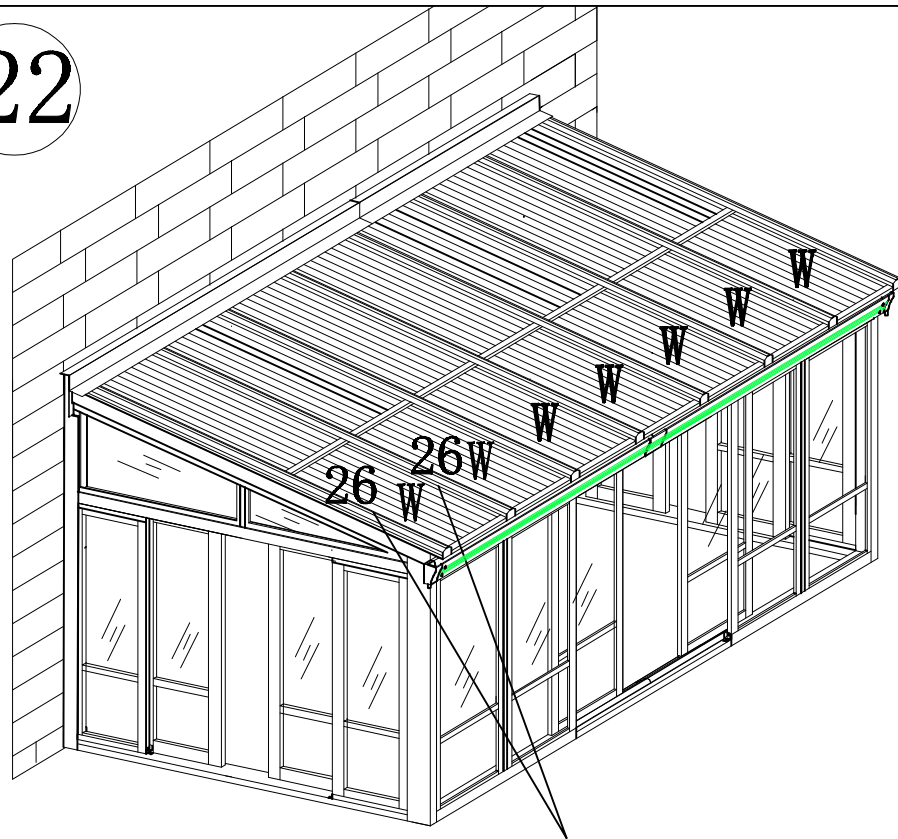

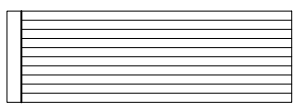
22

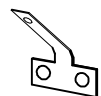

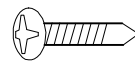
<p>W POLYCARBONATE</p>  <p>x7</p>	<p>19</p>  <p>x7</p>	<p>P</p>  <p>x8</p>	<p>X</p>  <p>x6</p>	<p>26</p> 	<p>Y</p>  <p>x6</p>	<p>A</p>  <p>x12</p>
--	---	--	--	---	--	---

23

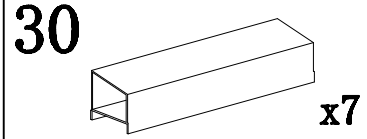
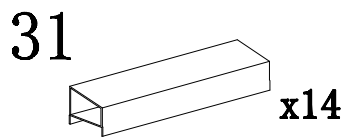
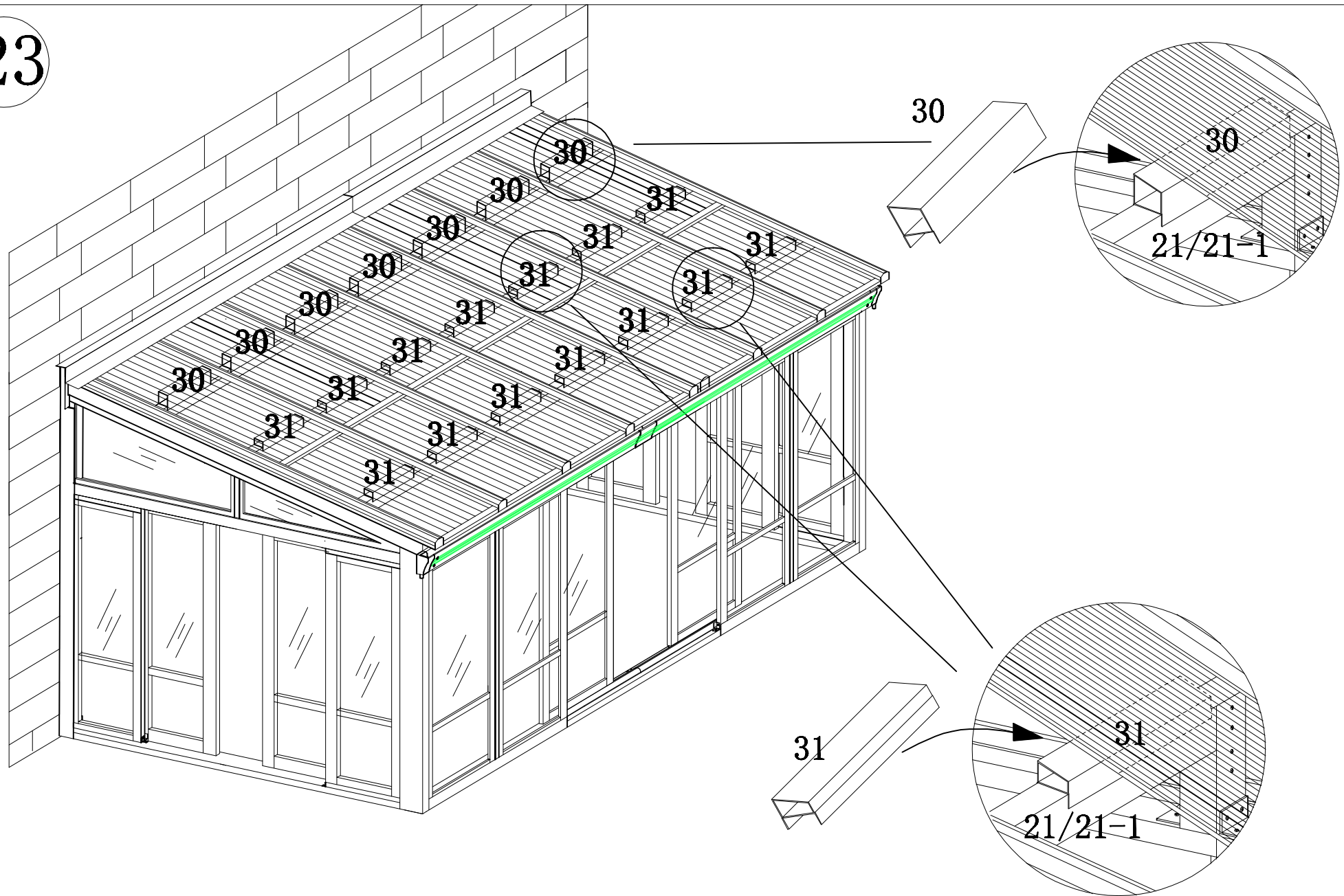

24

26

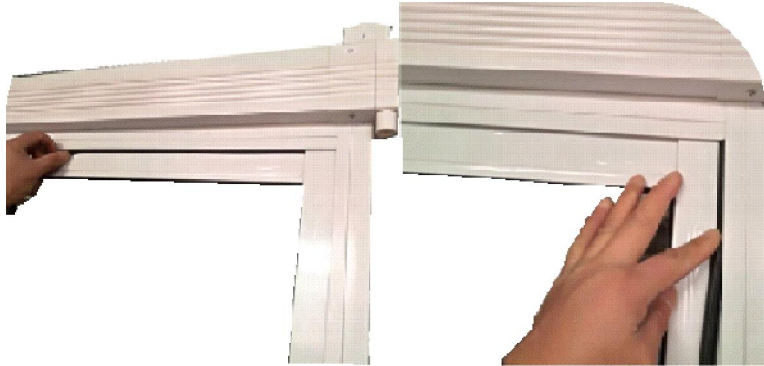
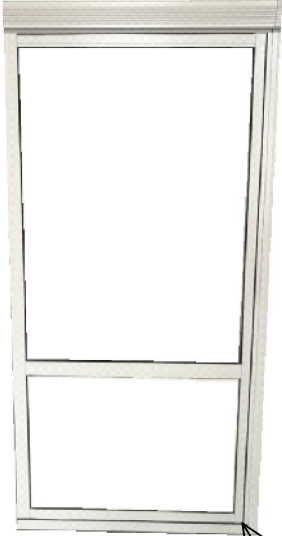
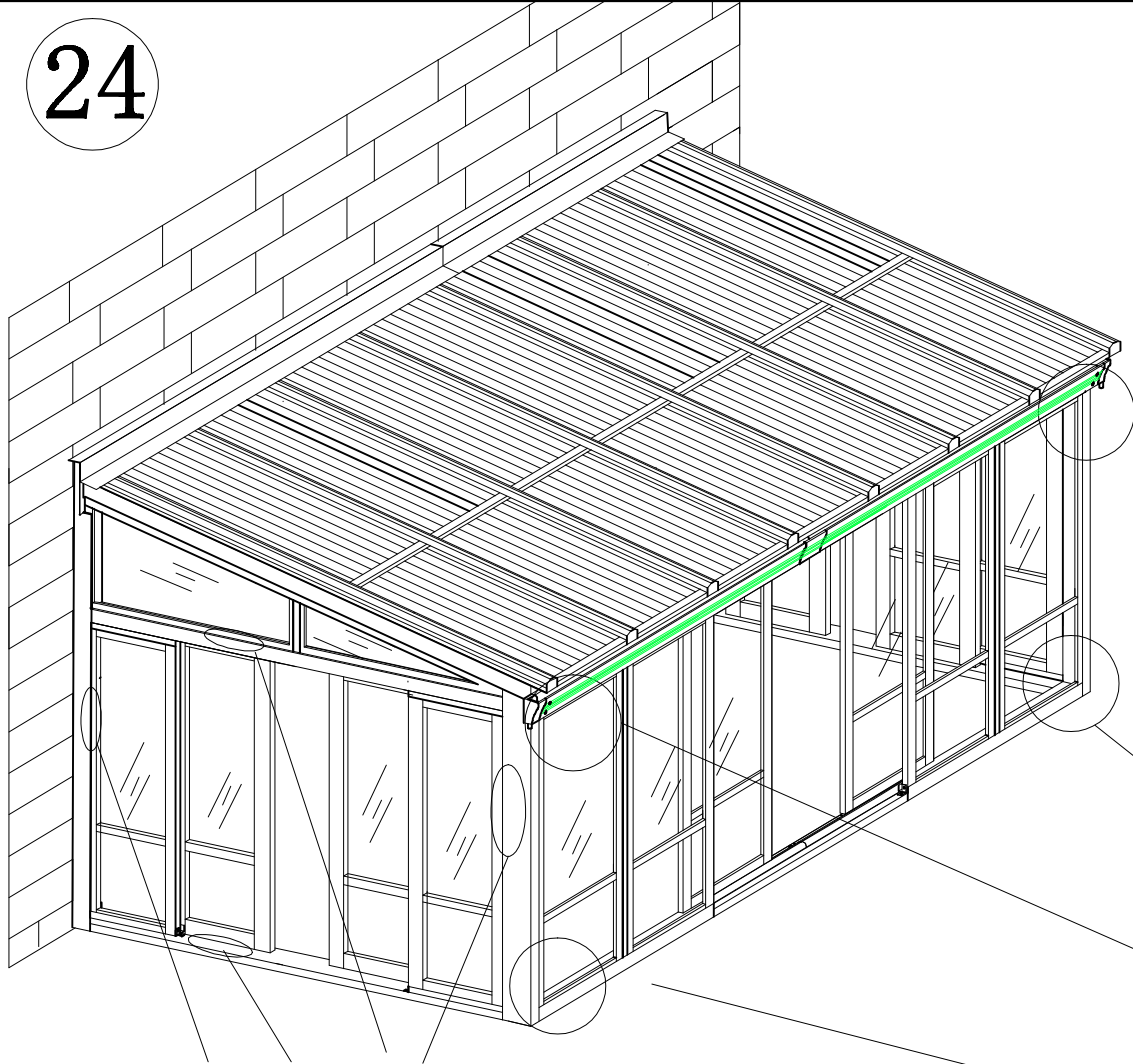

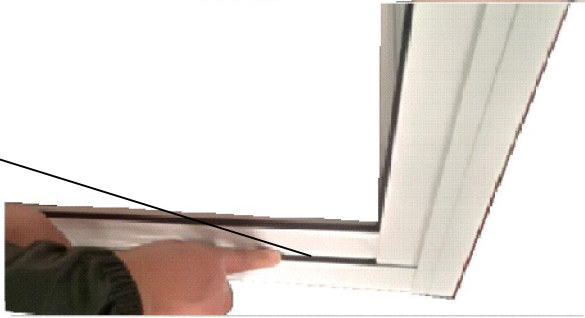

26

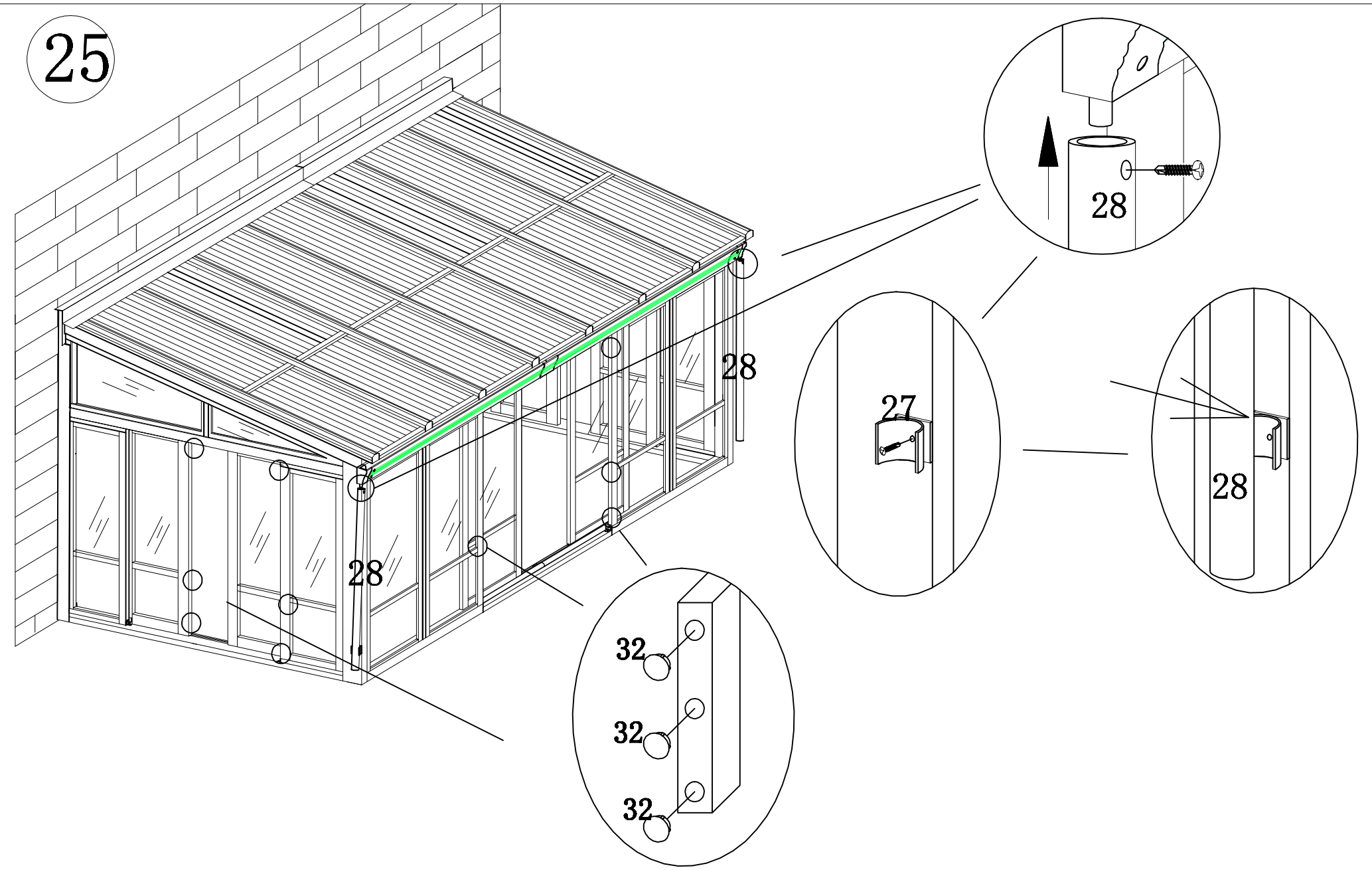

25

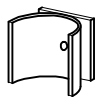
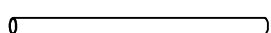
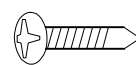

<p>27</p>  <p>x2</p>	<p>28</p>  <p>x2</p>	<p>A</p>  <p>x4</p>	<p>32</p>  <p>x50</p>
---	---	--	--

26

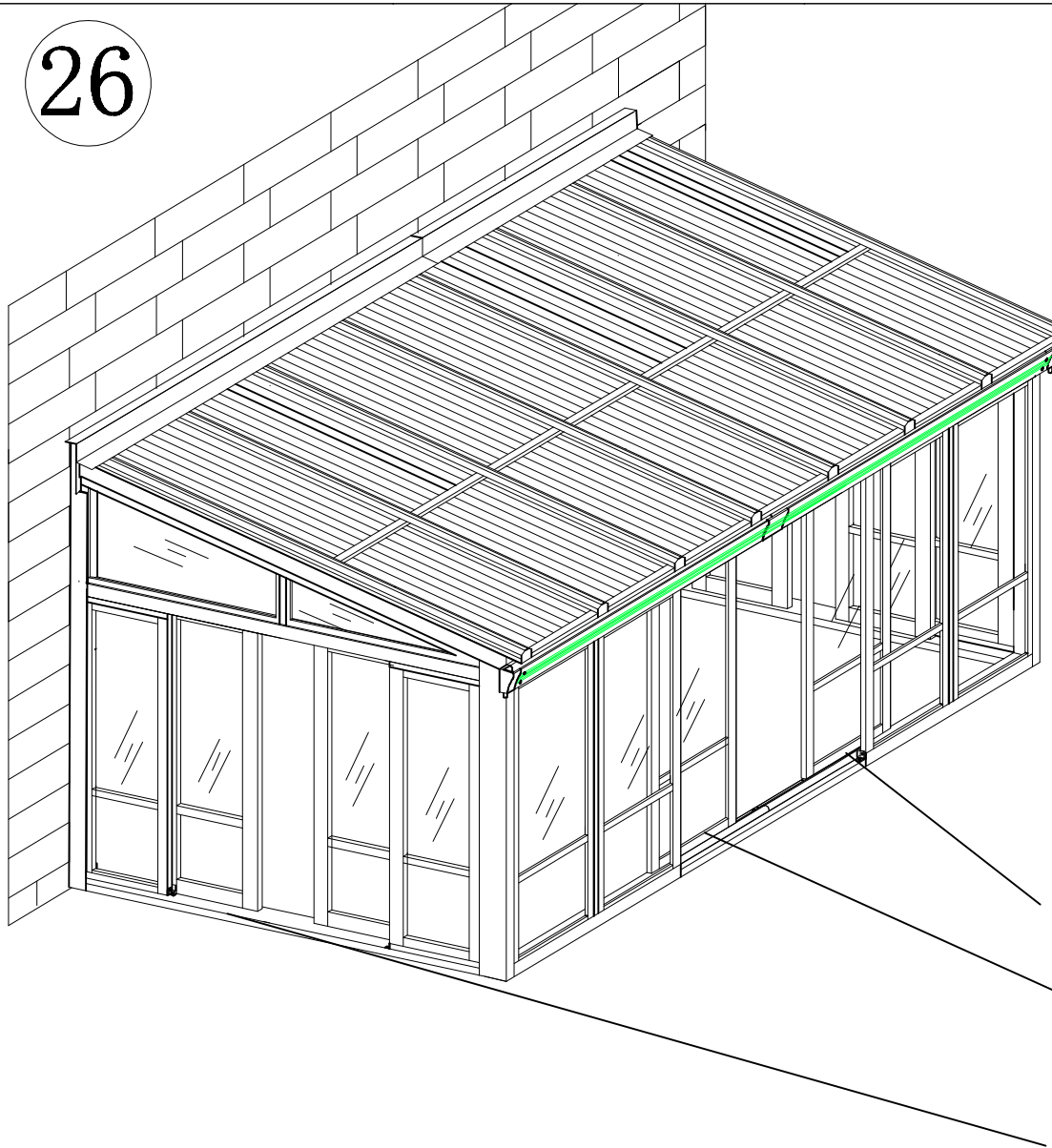

33



5m

x1