

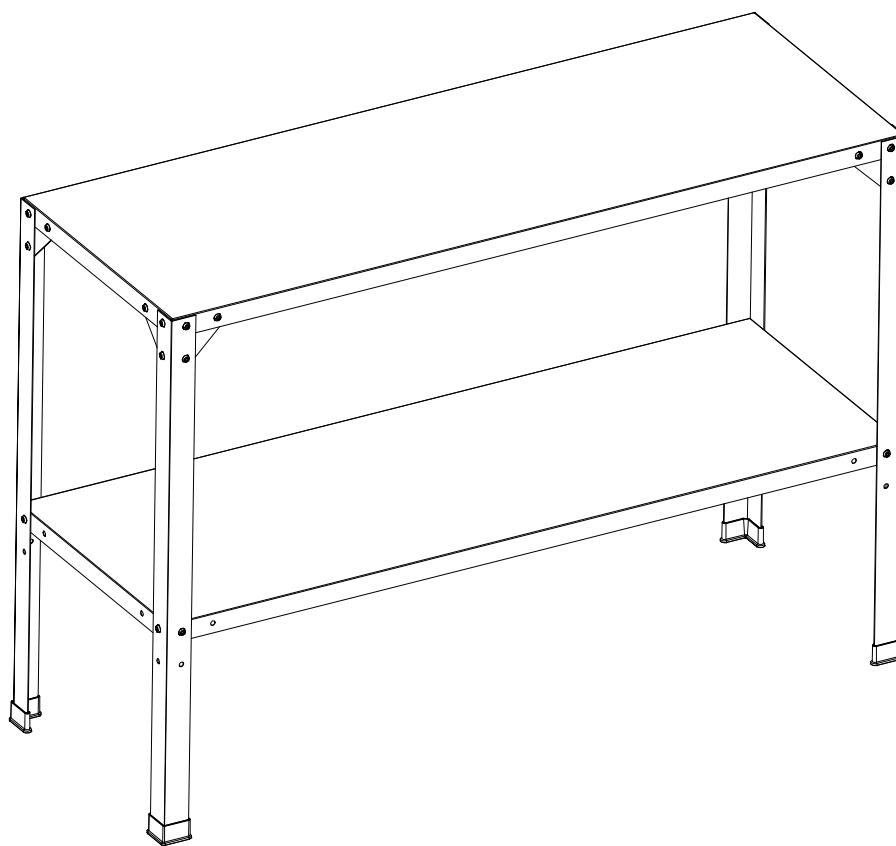







# Steel Staging-2 tier Assembly Instruction



Article number: 61613  
SIZE(LxWxH):115X41X80CM

PART	#	mm	Qty.
	A	40*40*800	4
	B	1150*410*30	2
	C	77*77*1.2	8
	D	47*47*29	4
	S01	M6*12	32
	M01	M6	32
	T	M4	1

